

BEGOLUX 
iluminação

begolux



A Begolux Iluminação, nasceu com o objetivo de complementar as soluções existentes no mercado nacional a nível de iluminação. No entanto, rapidamente evoluiu, de forma a poder responder com soluções inovadoras no campo da iluminação interior e exterior aos novos desafios funcionais e estéticos, com flexibilidade e eficácia.

Com uma equipa de concepção e desenvolvimento de produto fortemente motivada e experiente, e uma cobertura nacional e internacional, apresentamos soluções que valorizam o seu espaço.

Begolux, was born with the aim of complementing the existing solutions in the domestic market at the lighting level. However, it quickly evolve in order to be able to respond with innovative solutions in the field of interior and exterior lighting, to new functional and aesthetic challenges with flexibility and efficiency.

With a highly motivated and experienced product design and development team, and a national and international converging. We present solutions that value your space.

La marque Begolux, est née avec l'objectif d'offrir des solutions au niveau de l'éclairage pour combler les nécessités du marché national. Toutefois, l'entreprise a évolué rapidement afin de pouvoir répondre aux nouveaux défis tant en termes fonctionnels que en décoration grâce à l'innovation dans le domaine de l'éclairage intérieur et extérieur tout en flexibilité et efficacité. Avec une équipe de conception et de développement de produits fortement motivé et qualifiée, une couverture nationale et internationale, nous vous présentons des solutions qui valorise vos espaces.

a empresa **the company** l'entreprise

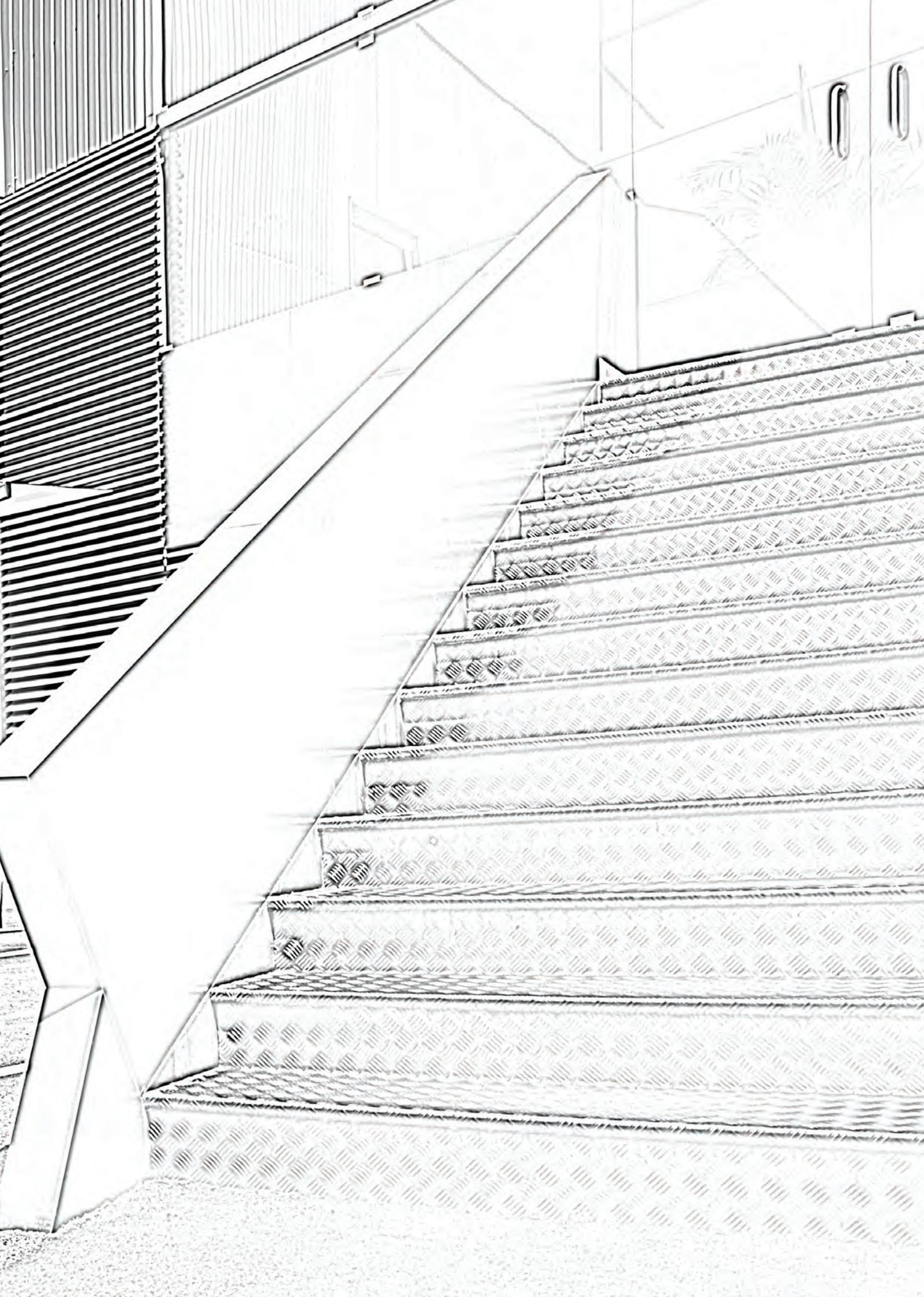

ARMADURAS

FIXTURES • ARMATURES

Axis Suspensa

Suspended • Suspendu

pág. 23

Beam

pág. 30

Eco LED

pág. 27

Infinity Dupla Suspensa

Double Suspended • Double Suspendu

pág. 16

Infinity Encastrar

Recessed • Encastré

pág. 18

Infinity Encastrar s/Aba

Recessed without Flapes • Encastré sans Rabats

pág. 19

Infinity Saliente

Surface Mounted • Plafonnier

pág. 14

Infinity Suspensa

Suspended • Suspendu

pág. 15

Linea LED Canto

Corner Profile • Profilé d'Angle

pág. 28

Linea LED Encastrar Alto

High Recessed Profile • Profilé Encastré Haut

pág. 28

Linea LED Encastrar Baixo

Low Recessed Profile • Profilé Encastré Bas

pág. 28

Linea LED Saliente

Surface Mounted Profile • Profilé Surface

pág. 28

Linear LED

pág. 26

Matrix

pág. 24

Ninfa

pág. 25

Oslo Câmpanula Industrial

High Bay • Cloche Industrielle

pág. 29

Tron Line Encastrar

Recessed • Encastré

pág. 22

Tron Line Saliente

Surface Mounted • Plafonnier

pág. 20

Tron Line Suspensa

Suspended • Suspendu

pág. 21

DOWNLIGHTS

DOWNLIGHTS • DOWNLIGHTS



Axa
Round/Square • Rond/Carré
pág. 39



Berna Acrílico
Acrylic • Acrylique
pág. 43



Berna Quadrado
Square • Carré
pág. 35



Berna Redondo
Round • Rond
pág. 34



Corvo LED
pág. 46



Ello
Round • Rond
pág. 40



Lightlens I/II
pág. 49



Lupo Quadrado
Square • Carré
pág. 37



Lupo Redondo
Rounded • Rond
pág. 36



Numi
pág. 44



Safira
Square • Carré
pág. 38



Store Focus
pág. 48



Vega
pág. 45



Veneza
Round • Rond
pág. 42



Zeto LED
pág. 47

index

INTERIOR SALIENTE/ENCASTRAR

INTERIOR SURFACE MOUNTED/RECESSED • INTÉRIEUR PLAFONNIER/ENCASTRÉ



Aqua
pág. 56



Nico
pág. 55



Demo
pág. 54



Primus
pág. 59



Giani
pág. 53



Primus Trio
pág. 60



Kleo
pág. 56



Quadra
pág. 52



Leda
pág. 52



Villa
pág. 60



Lumi
pág. 57



Lupi
pág. 57



Lyca
pág. 54



Magnum
pág. 55



Modular
pág. 58



Modular II
pág. 59

EXTERIOR PAREDE

EXTERIOR WALL
MURAL EXTÉRIEUR

-  Apolo
pág. 72
-  Apolo Ice
pág. 73
-  Apolo Ice Q
pág. 74
-  Apolo Q
pág. 75
-  Arges
pág. 64
-  Arges Duo
pág. 64
-  Delos
pág. 67
-  Elipse
pág. 71
-  Laus
pág. 66
-  Polo
pág. 67
-  Star
pág. 68
-  Star Duo
pág. 69
-  Urano
pág. 70

EXTERIOR CHÃO

EXTERIOR GROUND • EXTÉRIEUR SOL

-  Boxer
pág. 82
-  Deco
pág. 74
-  Flexi/Fexi Q
pág. 77
-  Gemini R
pág. 76
-  Gemini S
pág. 76
-  Limus
pág. 83
-  Sirius
pág. 84
-  Oceano
pág. 75

index

ILUMINAÇÃO PÚBLICA

STREET LIGHTING
LUMINAIRE PUBLIC



Argos
pág. 88



Nisa
pág. 89

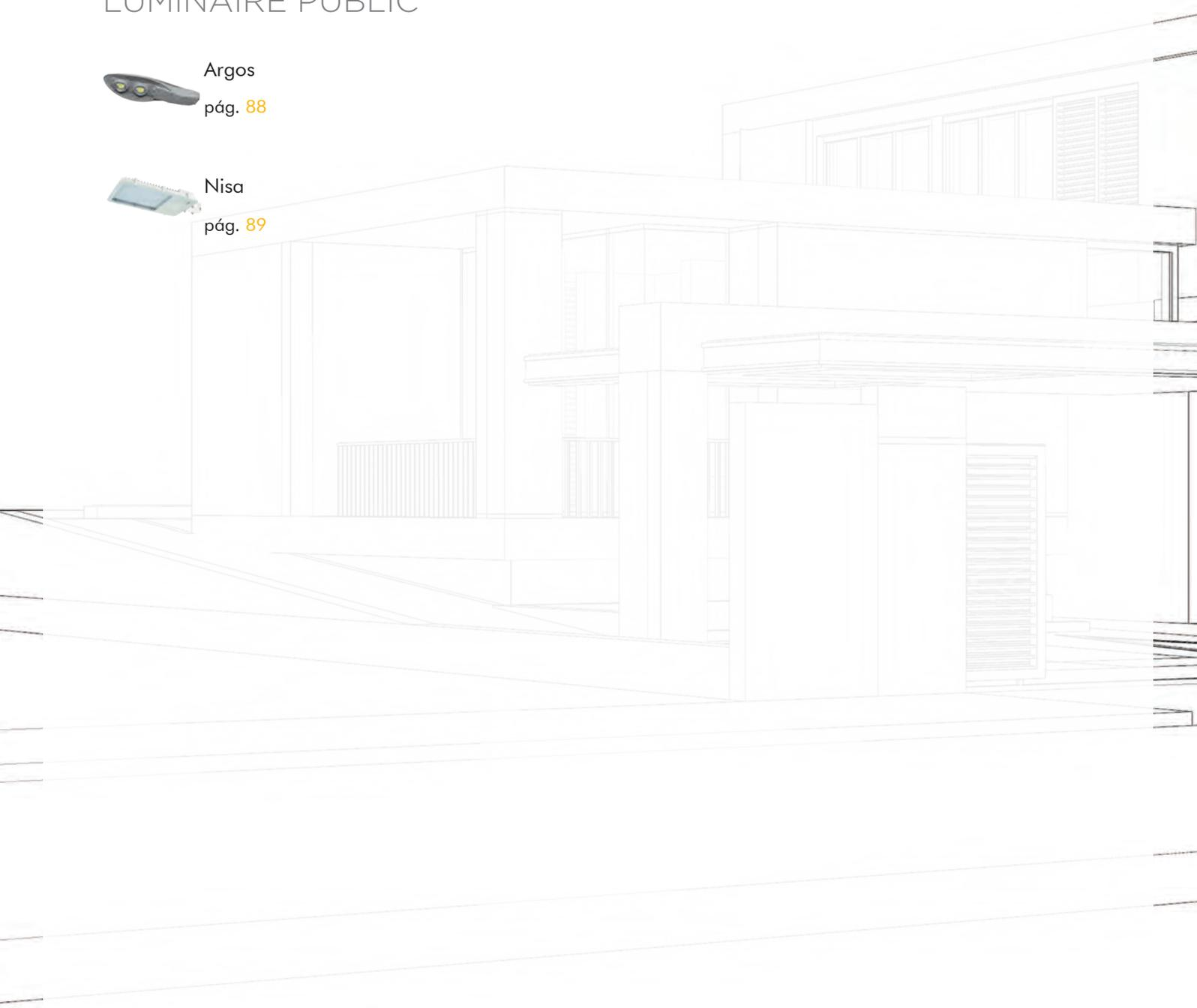

EXTERIOR PROJECTORES

EXTERIOR FLOOD LIGHT
PROJECTEUR EXTÉRIEUR



Douro
pág. 94



Mondego
pág. 93



Orion
pág. 95



Sado
pág. 92

DECORATIVA

DECORATIVE • DÉCORATIF



Abadia
pág. 98



Alpha
pág. 105



Alvor
pág. 103



Amazonas
pág. 114



Amos
pág. 110



Anik LED
pág. 136



Artemis
pág. 110



Baco
pág. 102



Bambola
pág. 113



Bonsai
pág. 120



Caria
pág. 100



Côa
pág. 142



Colombia
pág. 109



Cosmos LED
pág. 138



Delta B
pág. 122



Delta D
pág. 122



Disco LED
pág. 140



Draco LED
pág. 128



Eclipse
pág. 141



Era
pág. 104



Galaxy LED
pág. 126



Gama
pág. 106



Gio LED
pág. 131



Goes
pág. 116



Hydra LED
pág. 135



Indus LED
pág. 139



Leo LED
pág. 130



Levira
pág. 119



Lirio LED
pág. 135



Liz
pág. 109



Lotus
pág. 101



Luch
pág. 114



Mandala
pág. 113



Miro I
pág. 121



Miro II
pág. 121



Mundo Corda
pág. 115



Olimpia
pág. 106



Omega
pág. 105



Optus
pág. 116



Ota
pág. 101



Pegasus LED
pág. 132



Petros LED
pág. 128



Porto
pág. 104



Sigma LED
pág. 126



Sonata Q
pág. 124



Sonata R
pág. 124



Souto
pág. 99



Space LED
pág. 136



Taurus LED
pág. 133



Vau
pág. 98



Yami
pág. 119

Armaduras

Fixtures

Armatures

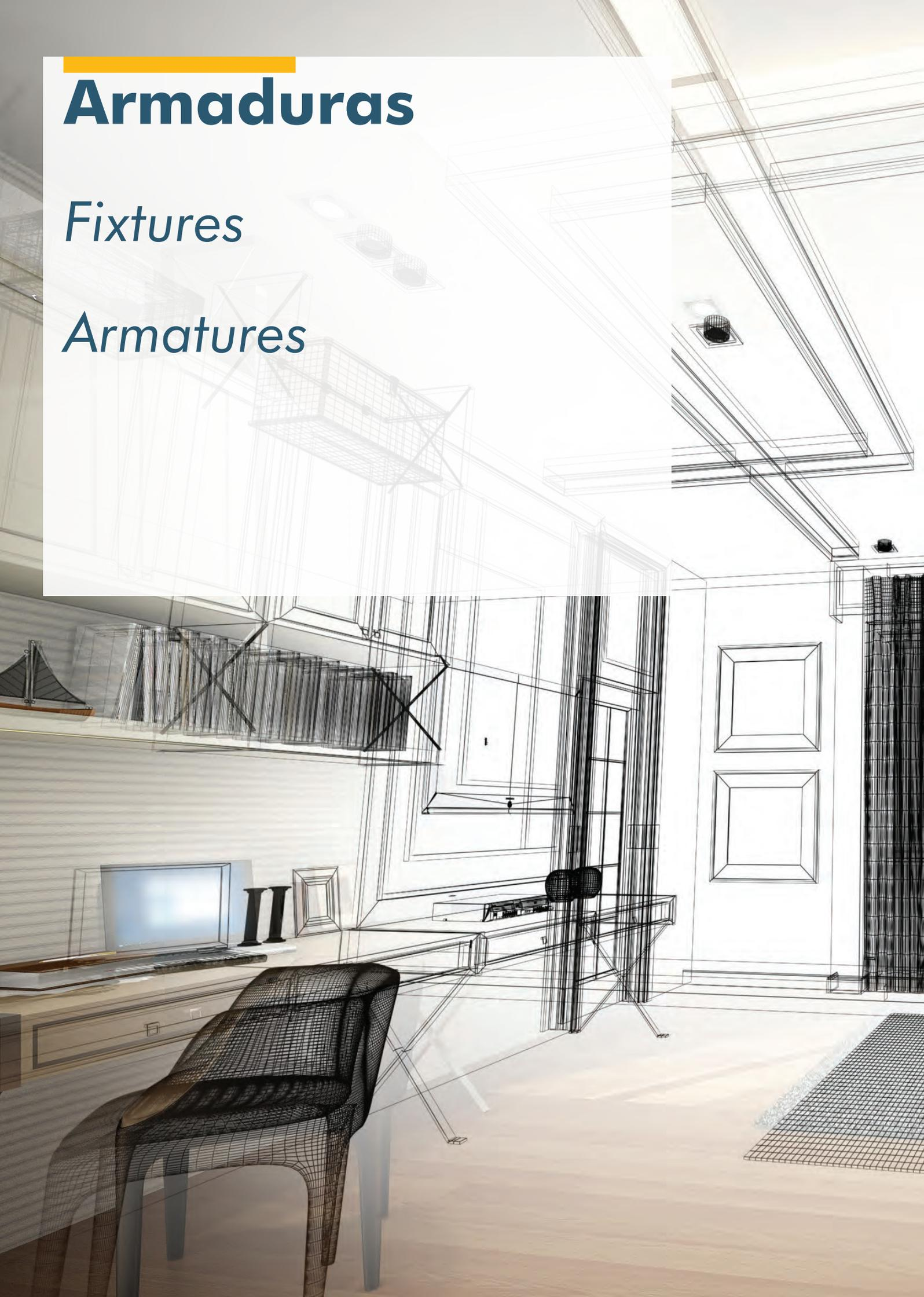

Axis Suspensa

Suspended • Suspendu
pág. 23

Beam

pág. 30

Eco LED

pág. 27

Infinity Dupla Suspensa

Double Suspended • Double Suspendu
pág. 16

Infinity Encastrar

Recessed • Encastré
pág. 18

Infinity Encastrar s/Aba

Recessed without Flapes • Encastré sans Rabats
pág. 19

Infinity Saliente

Surface Mounted • Plafonnier
pág. 14

Infinity Suspensa

Suspended • Suspendu
pág. 15

Linea LED Canto

Corner Profile • Profilé d'Angle
pág. 28

Linea LED Encastrar Alto

High Recessed Profile • Profilé Encastré Haut
pág. 28

Linea LED Encastrar Baixo

Low Recessed Profile • Profilé Encastré Bas
pág. 28

Linea LED Saliente

Surface Mounted Profile • Profilé Surface
pág. 28

Linear LED

pág. 26

Matrix

pág. 24

Ninfa

pág. 25

Oslo Câmpanula Industrial

High Bay • Cloche Industrielle
pág. 29

Tron Line Encastrar

Recessed • Encastré
pág. 22

Tron Line Saliente

Surface Mounted • Plafonnier
pág. 20

Tron Line Suspensa

Suspended • Suspendu
pág. 21

INFINITY

Saliente • Surface Mounted • Plafonnier

Descrição • Description • Description

Luminária de grande funcionalidade, de aspecto suave e elegante, de linhas rectas e sóbrias.

Armadura saliente com difusor fosco, com possibilidade de funcionamento on-off, controlo 1-10V, controlo DALI e com kit de emergência.

A sua multiplicidade de aplicações de linhas simples, individuais e/ou contínuas, assim como os vários tipos de acabamento, permite a sua integração em todos os tipos de espaços.

Ideal para ambientes de escritórios e empresariais.

Outstanding functional fixture, with a soft and elegant appearance with straight and sober lines.

Surface mounted fixture with frosted diffuser, with possibility of on-off operation, dimmer 1-10V, DALI dimmer and emergency kit.

Its multiplicity of applications of single, and/or continuous lines, as well as the various types of finishing, allows its integration in all types of spaces.

Ideal for office and business environments.

Plafonnier au design moderne propose une finition élégante de par ses lignes simples et épurées.

Avec diffuseur opaline et options; on-off, variateur 1-10V, contrôle DALI et éclairage de secours.

Installée seule ou en série, ainsi que différents types de finitions, permet son intégration dans tous les espaces.

Idéal pour les environnements de open-space/ bureau.



Difusor • Diffuser • Diffuseur

Polycarbonato
Polycarbonate
Polycarbonate

Lâmpadas • Lamps • Lampes

Módulo LED - LED Module - Module LED
T5
3000K / 4000K / 5000K.

Acessórios • Accessories • Accessoires

Regulação 1-10V, Controlo DALI,
Kit de emergência.
Dimmer 1-10V, DALI Dimmer,
Emergency kit.
Variateur 1-10V, Contrôle DALI,
Éclairage de secours.

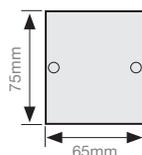

Linhas < 3m • Lines < 3m • Lignes < 3m

	LED			1 x T5	
	mm	w	Lumens	mm	w
Peça única Single piece Une seule pièce	565	17	2670 lm	600	14 / 24
	846	26	4010 lm	900	21 / 39
	1126	35	5350 lm	1200	28 / 54
	1407	44	6685 lm	1500	35 / 49 / 80
	1686	53	8025 lm	2 x T5	
	1966	62	9630 lm	600	28 / 48
	2246	71	10700 lm	900	42 / 78
	2527	79	12040 lm	1200	56 / 108
	2803	89	13376 lm	1500	70 / 98 / 160

Linhas ≥ 3m • Lines ≥ 3m • Lignes ≥ 3m

	LED		
	mm	w	Lumens
Múltiplas peças Customized Lines Pièces assemblées	3095	98	14715 lm
	3375	106	16050 lm
	3655	115	17385 lm
	3935	124	18725 lm
	4215	133	20060 lm
	4495	141	21400 lm
	4775	150	22740 lm

Outras medidas/potências a pedido

Others measures/powers on request

Autres mesures/puissances sur commande

Acabamento • Finishing • Finition

	Alumínio Aluminium Aluminium		Branco White Blanc		Bronze Brass Bronze		Faixa Beech Hêtre		Nogueira Walnut Noyer
	Carvalho Oak Chêne	*Outras cores a pedido Other colors on request Autres couleurs sur commande							

INFINITY

Suspensa • Suspended • Suspendu

Descrição • Description • Description

Luminária de grande funcionalidade, de aspecto suave e elegante, de linhas rectas e sóbrias.

Armadura suspensa com difusor fosco, com possibilidade de funcionamento on-off, controlo 1-10V, controlo DALI e com kit de emergência.

A sua multiplicidade de aplicações de linhas simples, individuais e/ou contínuas, assim como os vários tipos de acabamento, permite a sua integração em todos os tipos de espaços.

Ideal para ambientes de escritórios e empresariais.

Outstanding functional fixture, with a soft and elegant appearance with straight and sober lines.

Suspended fixture with frosted diffuser, with possibility of on-off operation, dimmer 1-10V, DALI dimmer and emergency kit.

Its multiplicity of applications of single, and / or continuous lines, as well as the various types of finishing, allows its integration in all types of spaces.

Ideal for office and business environments.

Cette suspension au design moderne propose une finition élégante de par ses lignes simples et épurées.

Avec diffuseur opaline et options; on-off, variateur 1-10V, contrôle DALI et éclairage de secours.

Installée seule ou en série, ainsi que différents types de finitions, permet son intégration dans tous les espaces.

Idéal pour les environnements de open- space/ bureau.



Difusor • Diffuser • Diffuseur

Policarbonato
Polycarbonate
Polycarbonate

Lâmpadas • Lamps • Lampes

Módulo led - LED module - Module led
T5
3000K / 4000K / 5000K.

Accessórios • Accessories • Accessoires

Regulação 1-10V, Controlo DALI, Kit de emergência, Kit suspensão, Cabo de alimentação.

Dimmer 1-10V, DALI Dimmer, Emergency kit, Suspension kit, Power cable.

Variateur 1-10V, Contrôle DALI

Éclairage de secours, Kit de Suspension, Câble d'alimentation.

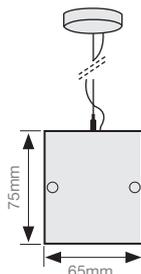

Linhas < 3m • Lines < 3m • Lignes < 3m

Peça única Single piece Une seule pièce	LED			1 x T5	
	mm	w	Lumens	mm	w
	565	17	2670 lm	600	14 / 24
846	26	4010 lm	900	21 / 39	
1126	35	5350 lm	1200	28 / 54	
1407	44	6685 lm	1500	35 / 49 / 80	
1686	53	8025 lm	2 x T5		
1966	62	9630 lm	600	28 / 48	
2246	71	10700 lm	900	42 / 78	
2527	79	12040 lm	1200	56 / 108	
2803	89	13376 lm	1500	70 / 98 / 160	

Linhas ≥ 3m • Lines ≥ 3m • Lignes ≥ 3m

Múltiplas peças Customized Lines Pièces assemblées	LED		
	mm	w	Lumens
3095	98	14715 lm	
3375	106	16050 lm	
3655	115	17385 lm	
3935	124	18725 lm	
4215	133	20060 lm	
4495	141	21400 lm	
4775	150	22740 lm	

Outras medidas/potências a pedido

Others mesures/powers on request

Autres mesures/puissances sur commande

Acabamento • Finishing • Finition

	Alumínio Aluminium Aluminium		Branco White Blanc		Bronze Brass Bronze		Faia Beech Hêtre		Nogueira Walnut Noyer
	Carvalho Oak Chêne	*Outras cores a pedido <i>Other colors on request</i> <i>Autres couleurs sur commande</i>							

INFINITY

Dupla Suspensa • Double Suspended • Double Suspended

Descrição • Description • Description

Luminária de grande funcionalidade, de aspecto suave e elegante, de linhas rectas e sóbrias.

Armadura dupla suspensa com difusor fosco, com possibilidade de funcionamento on-off, controlo 1-10V, controlo DALI e com kit de emergência.

A sua multiplicidade de aplicações de linhas simples, individuais e/ou contínuas, assim como os vários tipos de acabamento, permite a sua integração em todos os tipos de espaços.

Ideal para ambientes de escritórios e empresariais.

Outstanding functional fixture, with a soft and elegant appearance with straight and sober lines.

Double suspended fixture with frosted diffuser, with possibility of on-off operation, dimmer 1-10V, DALI dimmer and emergency kit.

Its multiplicity of applications of single, continuous and / or continuous lines, as well as the various types of finishing, allows its integration in all types of spaces.

Ideal for office and business environments.

Cette suspension double au design moderne propose une finition élégante de par ses lignes simples et épurées.

Avec diffuseur opaline et options; on-off, variateur 1-10V, contrôle DALI et éclairage de secours.

Installée seule ou en série, ainsi que différents types de finitions, permet son intégration dans tous les espaces.

Idéal pour tous les environnements de open- space/ bureau.

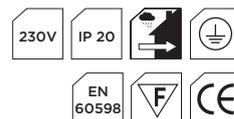

Difusor • Diffuser • Diffuseur

Policarbonato
Polycarbonate
Polycarbonate

Lâmpadas • Lamps • Lampes

Módulo led - LED module - Module led
T5
3000K / 4000K / 6000K.

Acessórios • Accessories • Accessoires

Regulação 1-10V, Controlo DALI, Kit de emergência, Kit suspensão, Cabo de alimentação.

Dimmer 1-10V, DALI Dimmer, Emergency kit, Suspension kit, Power cable.

Variateur 1-10v, Contrôle DALI

Éclairage de secours, Kit de Suspension, Câble d'alimentation.

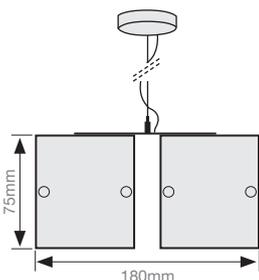

Linhas < 3m • Lines < 3m • Lignes < 3m

	LED			1 x T5	
	mm	w	Lumens	mm	w
Peça única Single piece Une seule pièce	565	34	5340 lm	600	28 / 48
	846	52	8020 lm	900	42 / 78
	1126	70	10700 lm	1200	56 / 108
	1407	88	13370 lm	1500	75 / 98 / 160
	1686	106	16050 lm	2 x T5	
	1966	124	19260 lm	600	56 / 96
	2246	142	21400 lm	900	84 / 156
	2527	158	24080 lm	1200	112 / 216
	2803	178	26752 lm	1500	140 / 196 / 320

Linhas ≥ 3m • Lines ≥ 3m • Lignes ≥ 3m

	LED			Outras medidas/potências a pedido Others measures/powers on request Autres mesures/puissances sur commande
	mm	w	Lumens	
Múltiplas peças Customized Lines Pièces assemblées	3095	196	29430 lm	
	3375	212	32100 lm	
	3655	230	34770 lm	
	3935	248	37450 lm	
	4215	266	40120 lm	
	4495	282	42800 lm	
	4775	300	45400 lm	

Acabamento • Finishing • Finition

	Alumínio Aluminium Aluminium		Branco White Blanc		Bronze Brass Bronze		Faia Beech Hêtre		Nogueira Walnut Noyer
	Carvalho Oak Chêne	*Outras cores a pedido Other colors on request Autres couleurs sur commande							



INFINITY

Encastrar • Recessed • Encastré

Descrição • Description • Description

Luminária de grande funcionalidade, de aspecto suave e elegante, de linhas rectas e sóbrias.

Armadura de encastrar com difusor fosco, com possibilidade de funcionamento on-off, controlo 1-10V, controlo DALI e com kit de emergência.

A sua multiplicidade de aplicações de linhas simples, individuais e/ou contínuas, assim como os vários tipos de acabamento, permite a sua integração em todos os tipos de espaços.

Ideal para ambientes de escritórios e empresariais.

Outstanding functional fixture, with a soft and elegant appearance with straight and sober lines.

Recessed mounting fixture with frosted diffuser, with possibility of on-off operation, dimmer 1-10V, DALI dimmer and emergency kit.

Its multiplicity of applications of single, continuous and / or continuous lines, as well as the various types of finishing, allows its integration in all types of spaces.

Ideal for office and business environments.

Luminaire d'encastrement au design moderne, propose une finition élégante de par ses lignes simples et épurées.

Avec diffuseur opaline et options; on-off, variateur 1-10V, contrôle DALI et éclairage de secours.

Installée seule ou en série, ainsi que différents types de finitions, permet son intégration dans tous les espaces.

Idéal pour les environnements de open-space/ bureau.

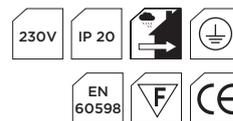
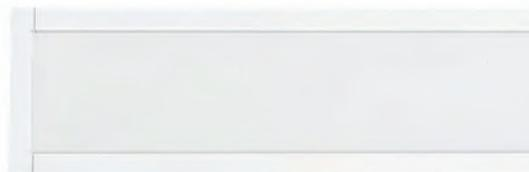

Difusor • Diffuser • Diffuseur

Policarbonato
Polycarbonate
Polycarbonate

Lâmpadas • Lamps • Lampes

Módulo led - LED module - Module led
T5
3000K / 4000K / 5000K.

Acessórios • Accessories • Accessoires

Regulação 1-10V, Controlo DALI,
Kit de emergência.

Dimmer 1-10V, DALI Dimmer, Emergency kit.

Variateur 1-10V, Contrôle DALI

Eclairage de secours.

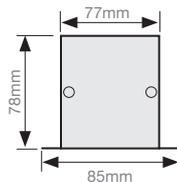

Linhas < 3m • Lines < 3m • Lignes < 3m

	LED			1 x T5	
	mm	w	Lumens	mm	w
Peça única Single piece Une seule pièce	565	17	2670 lm	600	14 / 24
	846	26	4010 lm	900	21 / 39
	1126	35	5350 lm	1200	28 / 54
	1407	44	6685 lm	1500	35 / 49 / 80
	1686	53	8025 lm	2 x T5	
	1966	62	9630 lm	600	28 / 48
	2246	71	10700 lm	900	42 / 78
	2527	79	12040 lm	1200	56 / 108
	2803	89	13376 lm	1500	70 / 98 / 160

Linhas ≥ 3m • Lines ≥ 3m • Lignes ≥ 3m

	LED			Outras medidas/potências a pedido Others measures/powers on request Autres mesures/puissances sur commande
	mm	w	Lumens	
Múltiplas peças Customized Lines Pièces assemblées	3095	98	14715 lm	
	3375	106	16050 lm	
	3655	115	17385 lm	
	3935	124	18725 lm	
	4215	133	20060 lm	
	4495	141	21400 lm	
	4775	150	22740 lm	

Acabamento • Finishing • Finition

 Alumínio Aluminium Aluminium	 Branco White Blanc	 Bronze Brass Bronze	 Faia Beech Hêtre	 Nogueira Walnut Noyer
 Carvalho Oak Chêne	*Outras cores a pedido Other colors on request Autres couleurs sur commande			

INFINITY

Encastrar s/ Aba • Recessed without Flaps • Encastré sans Rabats

Descrição • Description • Description

Luminária de grande funcionalidade, de aspecto suave e elegante, de linhas rectas e sóbrias.
 Armadura de encastrar sem aba com difusor fosco, com possibilidade de funcionamento on-off, controlo 1-10V, controlo DALI e com kit de emergência.
 A sua multiplicidade de aplicações de linhas simples, individuais e/ou contínuas, assim como os vários tipos de acabamento, permite a sua integração em todos os tipos de espaços.
 Ideal para ambientes de escritórios e empresariais.

Outstanding functional fixture, with a soft and elegant appearance with straight and sober lines.

Recessed without flaps mounting fixture with frosted diffuser, with possibility of on-off operation, dimmer 1-10V, DALI dimmer and emergency kit.

Its multiplicity of applications of single, continuous and / or continuous lines, as well as the various types of finishing, allows its integration in all types of spaces. Ideal for office and business environments.

Luminaire d'encastrement sans rabats au design moderne, propose une finition élégante de par ses lignes simples et épurées.

Avec diffuseur opaline et options: on-off, variateur 1-10V, contrôle DALI et éclairage de secours.

Installée seule ou en série, ainsi que différents types de finitions, permet son intégration dans tous les espaces.

Idéal pour tous les environnements de open-space/bureau.

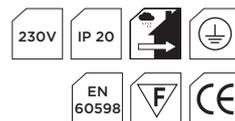
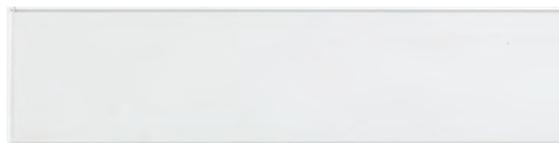

Difusor • Diffuser • Diffuseur

Policarbonato
 Polycarbonate
 Polycarbonate

Lâmpadas • Lamps • Lampes

Módulo led - LED module - Module led
 T5
 3000K / 4000K / 5000K

Accessórios • Accessories • Accessoires

Regulação 1-10V, Controlo DALI,
 Kit de emergência.
 Dimmer 1-10V, DALI Dimmer, Emergency kit.
 Variateur 1-10V, Contrôle DALI
 Éclairage de secours.

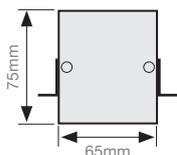

Linhas < 3m • Lines < 3m • Lignes < 3m

Peça única Single piece Une seule pièce	LED			1 x T5	
	mm	w	Lumens	mm	w
	565	17	2670 lm	600	14 / 24
846	26	4010 lm	900	21 / 39	
1126	35	5350 lm	1200	28 / 54	
1407	44	6685 lm	1500	35 / 49 / 80	
1686	53	8025 lm	2 x T5		
1966	62	9630 lm	600	28 / 48	
2246	71	10700 lm	900	42 / 78	
2527	79	12040 lm	1200	56 / 108	
2803	89	13376 lm	1500	70 / 98 / 160	

Linhas ≥ 3m • Lines ≥ 3m • Lignes ≥ 3m

Múltiplas peças Customized Lines Pièces assemblées	LED			Outras medidas/potências a pedido Others measures/powers on request Autres mesures/puissances sur commande
	mm	w	Lumens	
3095	98	14715 lm		
3375	106	16050 lm		
3655	115	17385 lm		
3935	124	18725 lm		
4215	133	20060 lm		
4495	141	21400 lm		
4775	150	22740 lm		

Acabamento • Finishing • Finition

- Alumínio
Aluminium
Aluminium
- Branco
White
Blanc
- Bronze
Brass
Bronze
- Faia
Beech
Hêtre
- Nogueira
Walnut
Noyer
- Carvalho
Oak
Chêne
- *Outras cores a pedido
Other colors on request
Autres couleurs sur commande

TRON LINE

Saliente • Surface Mounted • Plafonnier

Descrição • Description • Description

Luminária de grande funcionalidade, de aspecto suave e elegante, de linhas rectas e sóbrias.

Armadura saliente com difusor fosco, com possibilidade de funcionamento on-off, controlo 1-10V, controlo DALI e com kit de emergência.

A sua multiplicidade de aplicações de linhas simples, individuais e/ou contínuas, assim como os vários tipos de acabamento, permite a sua integração em todos os tipos de espaços.

Ideal para ambientes de escritórios e empresariais.

Outstanding functional fixture, with a soft and elegant appearance with straight and sober lines.

Surface mounted with frosted diffuser, with possibility of on-off operation, high efficiency, dimmer 1-10V, DALI dimmer and emergency kit. Its multiplicity of applications of single, continuous and / or continuous lines, as well as the various types of finishing, allows its integration in all types of spaces.

Ideal for office and business environments.

Plafonnier au design moderne propose une finition élégante de par ses lignes simples et épurées.

Avec diffuseur opaline et options; on-off, variateur 1-10V, contrôle DALI et éclairage de secours.

Installée seule ou en série, ainsi que différents types de finitions, permet son intégration dans tous les espaces.

Idéal pour les environnements de open-space/ bureau.

Difusor • Diffuser • Diffuseur

Policarbonato
Polycarbonate
Polycarbonate

Lâmpadas • Lamps • Lampes

Módulo led - LED module - Module led

3000K / 4000K / 5000K.

Acessórios • Accessories • Accessoires

Regulação 1-10V, Controlo DALI,
Kit de emergência.

Dimmer 1-10V, DALI Dimmer, Emergency kit.
Variateur 1-10V, Contrôle DALI
Éclairage de secours.



Linhas < 3m • Lines < 3m • Lignes < 3m

	LED		
	mm	w	Lumens
Peça única Single piece Une seule pièce	570	17	2670 lm
	850	26	4010 lm
	1130	35	5350 lm
	1410	44	6685 lm
	1690	53	8025 lm
	1970	62	9630 lm
	2250	71	10700 lm
	2530	79	12040 lm
	2810	89	13376 lm

Acabamento • Finishing • Finition

Alumínio Aluminium Aluminium
Branco White Blanc

Outras potências a pedido

Others powers on request

Autres puissances sur commande

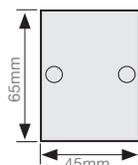

TRON LINE

Suspensa • Suspended • Suspendu

Descrição • Description • Description

Luminária de grande funcionalidade, de aspecto suave e elegante, de linhas rectas e sóbrias.

Armadura suspensa com difusor opalino, com possibilidade de selecção de funcionamento normal, alta eficiência, on-off, controlo 1-10V, controlo DALI e com kit de emergência. A sua multiplicidade de aplicações de linhas simples, individuais e/ou contínuas, assim como os vários tipos de acabamento, permite a sua integração em todos os tipos de espaços.

Ideal para ambientes de escritórios e empresariais.

Outstanding functional fixture, with a soft and elegant appearance with straight and sober lines.

Suspended fixture with frosted diffuser, with possibility of selection of normal operation, high efficiency, on-off, dimmer 1-10V, DALI dimmer and emergency kit.

Its multiplicity of applications of single, and / or continuous lines, as well as the various types of finishing, allows its integration in all types of spaces.

Ideal for office and business environments.

Suspension au design moderne propose une finition élégante de par ses lignes simples et épurées.

Avec diffuseur opaline et options; on-off, variateur 1-10V, contrôle DALI et éclairage de secours.

Installée seule ou en série, ainsi que différents types de finitions, permet son intégration dans tous les espaces.

Idéal pour les environnements de open-space/ bureau.

Difusor • Diffuser • Diffuseur

Polycarbonato
Polycarbonate
Polycarbonate

Lâmpadas • Lamps • Lampes

Módulo led - LED module - Module led

3000K / 4000K / 5000K.

Accessórios • Accessories • Accessoires

Regulação 1-10V, Controlo DALI,
Kit de emergência.
Dimmer 1-10V, DALI Dimmer, Emergency kit.
Variateur 1-10V, Contrôle DALI
Éclairage de secours.

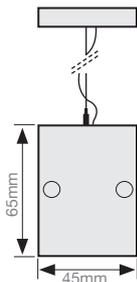

Linhas < 3m • Lines < 3m • Lignes < 3m

	LED		
	mm	w	Lumens
Peça única Single piece Une seule pièce	570	17	2670 lm
	850	26	4010 lm
	1130	35	5350 lm
	1410	44	6685 lm
	1690	53	8025 lm
	1970	62	9630 lm
	2250	71	10700 lm
	2530	79	12040 lm
	2810	89	13376 lm

Acabamento • Finishing • Finition



Outras potências a pedido

Others powers on request

Autres puissances sur commande



TRON LINE

Encastrar • Recessed • Encastré

Descrição • Description • Description

Luminária de grande funcionalidade, de aspecto suave e elegante, de linhas rectas e sóbrias.

Armadura de encastrar com difusor fosco, com possibilidade de funcionamento on-off, controlo 1-10V, controlo DALI e com kit de emergência.

A sua multiplicidade de aplicações de linhas simples, individuais e/ou contínuas, assim como os vários tipos de acabamento, permite a sua integração em todos os tipos de espaços.

Ideal para ambientes de escritórios e empresariais.

Outstanding functional fixture, with a soft and elegant appearance with straight and sober lines.

Recessed mounting fixture with frosted diffuser, with possibility of on-off operation, high efficiency, dimmer 1-10V, DALI dimmer and emergency kit.

Its multiplicity of applications of single, continuous and / or continuous lines, as well as the various types of finishing, allows its integration in all types of spaces.

Ideal for office and business environments.

Luminaire d'encastré au design moderne propose une finition élégante de par ses lignes simples et épurées.

Avec diffuseur opaline et options; on-off, variateur 1-10V, contrôle DALI et éclairage de secours.

Installée seule ou en série, ainsi que différents types de finitions, permet son intégration dans tous les espaces.

Idéal pour les environnements de open- space/ bureau.

Difusor • Diffuser • Diffuseur

Policarbonato
Polycarbonate
Polycarbonate

Lâmpadas • Lamps • Lampes

Módulo LED - LED Module - Module LED

3000K / 4000K / 5000K.

Acessórios • Accessories • Accessoires

Regulação 1-10V, Controlo DALI,
Kit de emergência.

Dimmer 1-10V, DALI Dimmer, Emergency kit.

Variateur 1-10V, Contrôle DALI

Éclairage de secours.

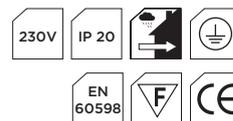

Linhas < 3m • Lines < 3m • Lignes < 3m

LED			
	mm	w	Lumens
Peça única Single piece Une seule pièce	570	17	2670 lm
	850	26	4010 lm
	1130	35	5350 lm
	1410	44	6685 lm
	1690	53	8025 lm
	1970	62	9630 lm
	2250	71	10700 lm
	2530	79	12040 lm
	2810	89	13376 lm

Acabamento • Finishing • Finition

Alumínio Aluminium Aluminium
Branco White Blanc

Outras potências a pedido

Others powers on request

Autres puissances sur commande

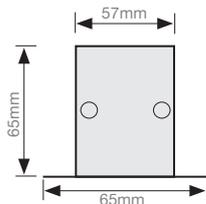

AXIS

Suspensa • Suspended • Suspendu

Descrição • Description • Description

Luminária de grande funcionalidade, de linhas rectas discretas.

Armadura suspensa com difusor PMMA, com possibilidade de selecção de funcionamento on-off, controlo 1-10V, controlo DALI e com kit de emergência.

A sua multiplicidade de aplicações de linhas simples ou contínuas, permite a sua integração em todos os tipos de espaços. Ideal para ambientes comerciais, supermercados, escritórios e empresariais.

Outstanding functional fixture, with a straight and discreet line.

Suspended fixture with PMMA diffuser, with possibility of on-off operation, dimmer 1-10V, DALI dimmer and emergency kit.

Its multiplicity of applications of single or continuous lines, allows its integration in all types of spaces.

Ideal for commercial, markets, supermarkets, office and business environments.

Suspension au design moderne propose une finition élégante de par ses lignes simples et épurées.

Avec diffuseur clair et options; on-off, variateur 1-10V, contrôle DALI et éclairage de secours.

Installée seule ou en série, ainsi que différents types de finitions, permet son intégration dans tous les espaces.

Idéal pour les environnements de open-space/ bureau.



Difusor • Diffuser • Diffuseur

PMMA Simétrico ou Assimétrico
PMMA Symetric or Assimetric
PMMA Simetrique ou Assymetrique

Lâmpadas • Lamps • Lampes

Módulo led - LED module - Module led

3000K / 4000K / 5000K.

Acessórios • Accessories • Accessoires

Regulação 1-10V, Controlo DALI,
Kit de emergência.
Dimmer 1-10V, DALI Dimmer, Emergency kit.
Variateur 1-10V, Contrôle DALI
Éclairage de secours.

Acabamento • Finishing • Finition

Branco
White
Blanc

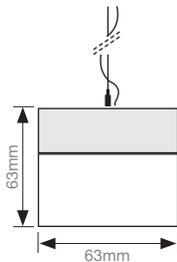

MATRIX

Descrição • Description • Description

Armadura constituída por diversos módulos de perfil de alumínio em U, que se integram entre si com lâmpadas T5, obtendo assim, uma harmoniosa linha de luz sem interrupções.

Poder ser feito por medida.

Ideal para sancas, corredores, ambientes hospitalares e escolares.

Fixture that consists of several modules of U-shaped aluminum profile, which integrate with each other with T5 lamps, obtaining a harmonious line of light without interruptions. It can be customized. Ideal for crown molding, corridors, hospital and school environments.

Structure composée de plusieurs modules en aluminium de format U, qui sont connecté ensemble avec lampes T5, obtenant ainsi une ligne harmonieuse de la lumière sans interruption.

Il peut être produite sur mesure.

Idéal pour les corniches ou faux-plafond, les couloirs, les hôpitaux et écoles.



Lâmpadas • Lamps • Lampes

T5 - 3000K / 4000K / 6000K

Acessórios • Accessories • Accessoires

Regulação de fluxo, Kit Emergência.

Dimmer Ballast, Emergency kit.

Contrôle d'intensité, Éclairage de secours.

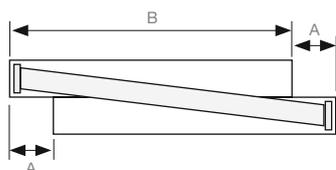
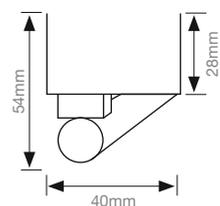

Matrix	w	AxBxA (mm)
600	1 x 14w / 1 x 24w	135x579x135
900	1 x 21w / 1 x 39w	135x878x135
1200	1 x 24w / 1 x 28w	135x1179x135
1500	1 x 35w / 1 x 49w / 1 x 80w	135x1478x135
2250	2 x 28w / 2 x 54w	135x2249x135
2850	2 x 35w / 2 x 49w / 2 x 80w	135x2844x135

Acabamento • Finishing • Finition

Branco
White
Blanc



NINFA

Descrição • Description • Description

Armadura com led integrado, que assegura uma iluminação mais funcional, aumentando a comodidade e a segurança. Disponível em vários tamanhos, de 600mm a 1500mm, para uma maior diversidade de aplicações.

Equipment with integrated led, which ensures a more functional lighting, increasing the convenience and safety. Available in various sizes, from 600mm to 1500mm, for a greater diversity of applications.

Appareil avec led intégrée, qui assure un éclairage fonctionnel, augmentant la commodité et la sécurité. Disponible en différentes tailles, de 600mm à 1500mm, dans une grande variété d'espace.



Difusor • Diffuser • Diffuseur

PVC

Lâmpadas • Lamps • Lampes

LED 4000K

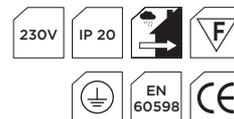

Acessórios • Accessories • Accessoires

Cabo de ligação, conectores entre armaduras e fixadores de tecto/parede.
Connecting cable, connectors between lighting fixtures and ceiling/wall fasteners.
 Câble de raccordement, connecteurs entre la luminaire et le plafond / fixations murales.

AxBxC (mm)	w	nº Máximo de Ligações Maximum Connections nº Maximum Connections nº
565x23x35	9	10
882x23x35	14	8
1185x23x35	18	6
1475x23x35	22	5

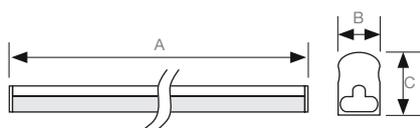

Acabamento • Finishing • Finition

Alumínio
 Aluminium
 Aluminium



LINEAR LED / LINEAR LED RGB

Descrição • Description • Description

Linear LED é uma fita com cobertura e um IP55 que permite a sua aplicação no exterior. Nesta gama existem dois tipos de fita de led's, uma com 60 led's/m de elevado rendimento, e outra com 96 led's que permite uma elevada homogeneidade de luz ao longo de toda a fita de led's.

Com fita adesiva para uma aplicação mais fácil.

Aconselhamos, a utilização de perfil de alumínio aquando a aplicação de fita.

Linear LED it's a led strip with cover, and IP55. In this range there are two types of led strips, one with 60 high performance leds and the other with 96 led's that allow a high homogeneity of light along the entire led strip.

With adhesive tape for easier application. We advise the use of aluminum profile when applying led strip.

Linear LED est une ruban led avec ruban adhésif et IP55 qui permet son application à l'exterieur.

Dans cette gamme, il existe deux types de ruban de led, une avec 60 leds / m avec un rendement élevé, et l'autre led 96 qui permet une grande homogénéité de la lumière le long des leds.

Nous recommandons l'utilisation d'un profilé en aluminium lors de l'application du ruban.

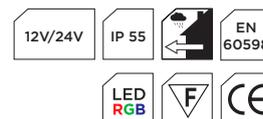

Lâmpadas • Lamps • Lampes

LED 12V / 24V

w	nº de LED LED nº nº de LED	Intervalos de corte Cutting breaks Recoupables tous les	V
7,2W/m	96/m	30 mm	12V / 24V
14,4W/m	60/m	100 mm	12V / 24V

Acessórios • Accessories • Accessoires

	w	V
LED Driver	25	12V / 24V
LED Driver	50	12V / 24V
LED Driver	100	12V / 24V
LED Driver	150	12V / 24V
LED Driver	200	12V / 24V
LED Driver	250	12V / 24V
Controlador RGB • RGB Controller • RGB Controller		12V / 24V
Amplificador • Amplifier • Amplifier		12V / 24V



ECO LED

Descrição • Description • Description

Eco led é uma fita sem cobertura, de IP20 que permite a sua aplicação no interior. Nesta gama existem dois tipos de fita de led's, uma com 60 led's/m de elevado rendimento, e outra com 96 led's que permite uma elevada homogeneidade de luz ao longo de toda a fita de led's. Com fita adesiva para uma aplicação mais fácil.

Aconselhamos, a utilização de perfil de alumínio aquando a aplicação de fita.

Eco LED it's a led strip without cover, and IP20. In this range there are two types of led strips, one with 60 high performance leds and the other with 96 led's that allow a high homogeneity of light along the entire led strip. We advise the use of aluminum profile when applying led strip.

Eco LED est un ruban led avec ruban adhésif et IP20 qui permet son application à l'intérieur.

Dans cette gamme, il existe deux types de ruban de led, une avec 60 leds / m avec un rendement élevé, et l'autre led 96 qui permet une grande homogénéité de la lumière le long des leds.

Nous recommandons l'utilisation d'un profilé en aluminium lors de l'application du ruban.

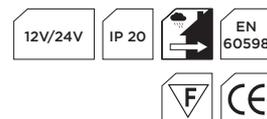

Lâmpadas • Lamps • Lampes

LED 12V / 24V

w	nº de LED LED nº nº de LED	Intervalos de corte Cutting breaks Recoupables tous les	V
7,2W/m	96/m	30 mm	12V / 24V
14,4W/m	60/m	100 mm	12V / 24V

Acessórios • Accessories • Accessoires

	w	V
LED Driver	25	12V / 24V
LED Driver	50	12V / 24V
LED Driver	100	12V / 24V
LED Driver	150	12V / 24V
LED Driver	200	12V / 24V
LED Driver	250	12V / 24V



LINEALED

Perfil • Profile • Profilé

Descrição • Description • Description

Perfil de alumínio extrafino, que poderá ser saliente, encastrar ou de canto e que ficará completo com a colocação de um difusor transparente ou fosco. Na versão de encastrar temos disponíveis um perfil de maior profundidade e um com menos profundidade. Para a instalação destes vários tipos de perfil, dispomos de um conjunto de acessórios, tais como, molas de fixação, topo passa cabos, topo terminal.

Extra thin aluminum profile, which can be surface mounted, recessed or corner and completed with the placement of a transparent or frost diffuser. In the recessed version, we have available two profiles of greater or small depth.

For the installation of these various types of profile, we have a set of accessories, such as fixing springs, end cap with and without hole.

Profilé en aluminium extra mince, qui peut être monté en surface, encastré et coin avec diffuseur transparent ou de opaline. Dans la version encastrée, nous disposons de deux profils de plus ou moins grande profondeur. Pour l'installation de ces différents types de profilé, nous avons un ensemble d'accessoires, tels que; ressorts de fixation, embout avec et sans trou.

Difusor • Diffuser • Diffuseur

Transparente / Fosco
Clear / Frosted
Clair / Opaline

Lâmpadas • Lamps • Lampes

Fita de led
LED strip
Ruban led

Acessórios • Accessories • Accessoires

Molas de fixação, Topo passa cabos,
Topo terminal.
*Fixing clips, End cap with hole,
End cap without hole.
Ressorts de Fixation, Embout avec trou,
Embout sans trou.*



Perfil de Encastrar Alto
High Recessed Aluminium Profile
Profilé Encastré haut en Aluminium

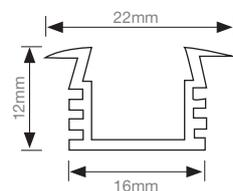

Perfil de Encastrar Baixo
Low Recessed Aluminium Profile
Profilé Encastré bas en Aluminium

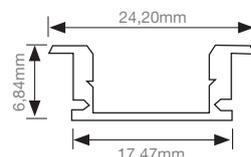

Perfil Saliente
Surface Mounted Profile
Profilé Surface

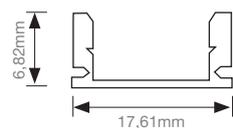

Perfil de canto
Corner Profile
Profilé d'angle 90°

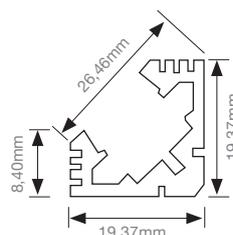

OSLO

Campânula Industrial • High Bay • Cloche Industrielle

Descrição • Description • Description

Campânula industrial led, construída totalmente em alumínio com dissipador de calor de grande capacidade. Produto projectado e desenvolvido para a iluminação de grandes áreas tais como armazéns, oficinas e pavilhões industriais. Disponível nas potências de 50W, 90W, 150W e 180W com reflector de 120°.

High bay industrial led, built entirely in aluminum with large capacity heat fins. Product designed and developed for lighting large areas such as warehouses, workshops and industrial pavilions. Available in power range of 50W, 90W, 150W and 180W with 120° reflector.

Cloche led industrielle, entièrement construit en aluminium avec grande capacité dissipateur thermique. Produit conçu et développé pour l'éclairage de grandes surfaces telles que, entrepôts, ateliers et des bâtiments industriels. Disponible en puissances de 50W, 90W, 150W et 180W avec faisceau de 120°.

Difusor • Diffuser • Diffuseur

Lentes em PMMA.
PMMA Lenses.
PMMA Lentilles.

Lâmpadas • Lamps • Lampes

LED 6000K

Incluído • Included • Inclus

Reflector 120°.
120° Reflector.
Angle Faisceau 120°.

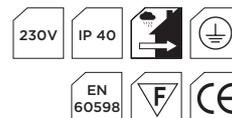

Oslo	AxBxCxD (mm)	Lumens
50 W	210x380x500x240	4500 lm
90 W	210x380x500x240	8100 lm
150 W	270x405x500x255	13500 lm
180 W	270x460x500x310	16200 lm

Acabamento • Finishing • Finition

Alumínio
Aluminium
Aluminium

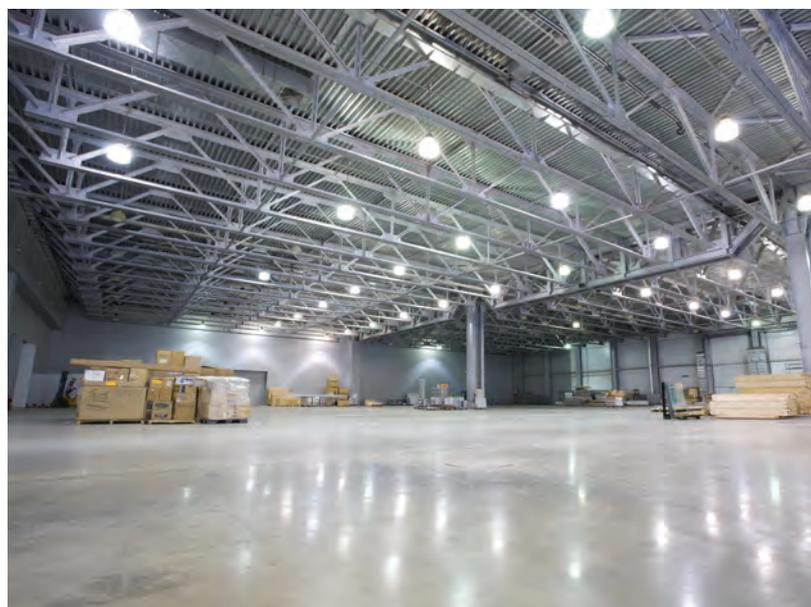
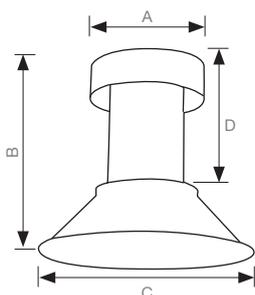

BEAM

Descrição • Description • Description

Armadura estanque com led integrado, construída totalmente em Policarbonato. Produto projectado e desenvolvido para uma fácil substituição de iluminação de grandes áreas tais como armazéns, oficinas e pavilhões industriais. Uso interior e exterior. Disponível nas potências de 18W, 24W, 36W e 48W.

Waterproof fixture with integrated led, constructed entirely in polycarbonate. Product designed and developed for easy installation of large areas such as warehouses, workshops and industrial pavilions. Indoor and outdoor use. Available in powers of 18W, 24W, 36W and 48W.

Luminaire étanche, entièrement construite en polycarbonate. Produit conçu et développé pour faciliter le remplacement des grandes surfaces d'éclairage, telles que, entrepôts, ateliers et bâtiments industriels. Intérieur et extérieur. Disponible en puissances de 18W, 24W, 36W et 48W.

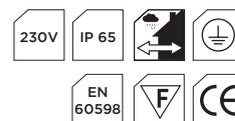

Difusor • Diffuser • Diffuseur

Fosco
Frost
Opaline

Lâmpadas • Lamps • Lampes

LED 4000K

Beam	AxBxC (mm)	Lumens
18 W	603x102x60	1620 lm
24 W	938x102x60	2160 lm
36 W	1210x102x60	3240 lm
48 W	1500x102x60	4320 lm

Acessórios • Accessories • Accessoires

Cabo de ligação, Conectores entre armaduras e Fixadores de tecto/parede.
Connecting cable, connectors between lighting fixtures and ceiling/wall fasteners.
Câble de raccordement, connecteurs entre la luminaire et le plafond / fixations murales.

Acabamento • Finishing • Finition

■ Policarbonato
■ Polycarbonate
■ Polycarbonate

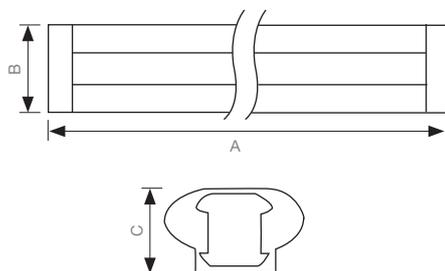



THE POINT

Downlights

Downlights

Downlights

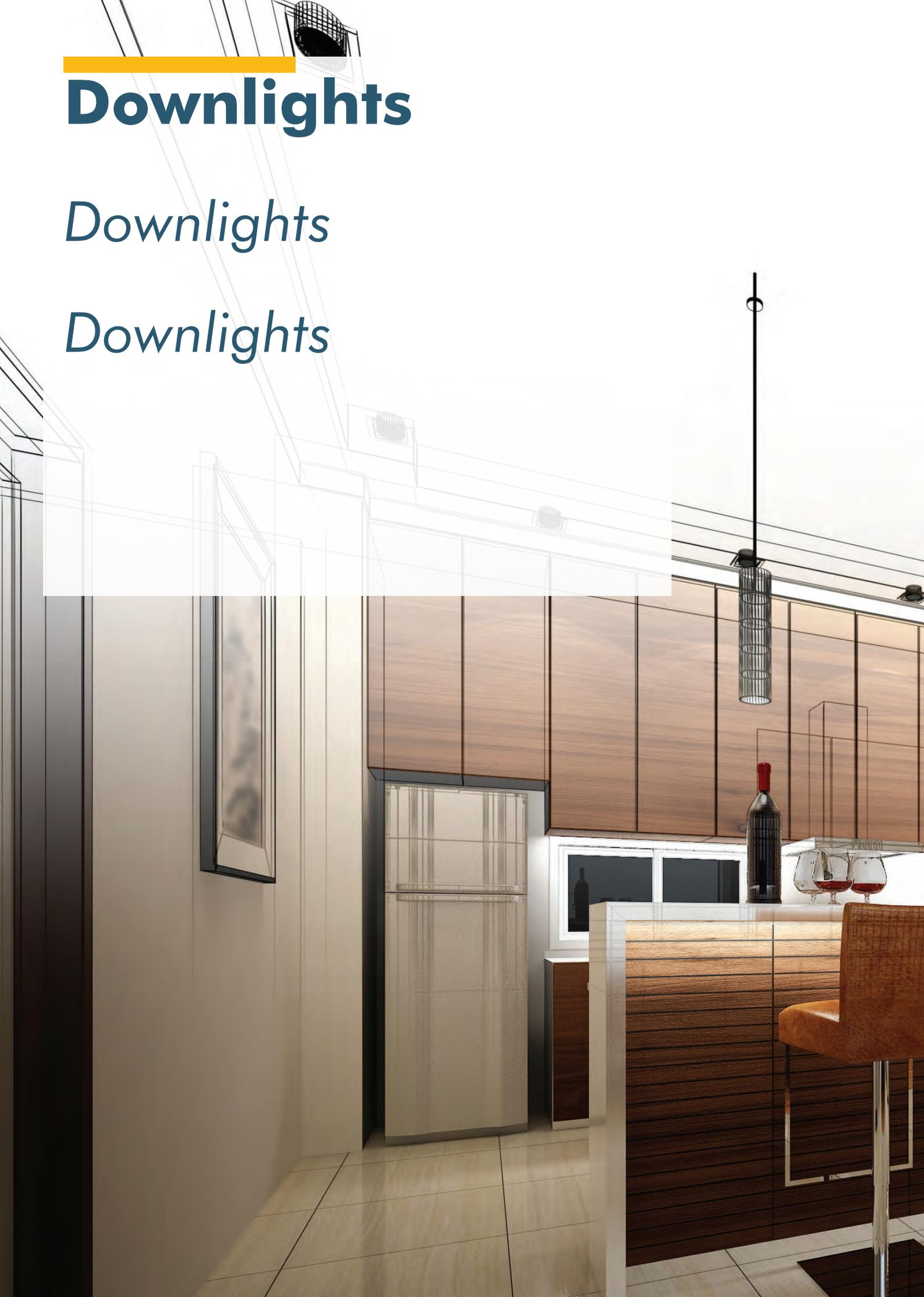

Axa

Round/Square • Rond/Carré
pág. 39

Berna Acrílico

Acrylic • Acrylique
pág. 43

Berna Redondo

Round • Rond
pág. 34

Berna Quadrado

Square • Carré
pág. 35

Corvo LED

pág. 46

Ello

Round • Rond
pág. 40

Lightlens I/II

pág. 49

Lupo Quadrado

Square • Carré
pág. 37

Lupo Redondo

Rounded • Rond
pág. 36

Numi

pág. 44

Safira

Square • Carré
pág. 38

Store Focus

pág. 48

Vega

pág. 45

Veneza

Round • Rond
pág. 42

Zeto LED

pág. 47

BERNA

Redondo • Round • Rond

Descrição • Description • Description

A linha Berna Redondo é uma gama de luminárias de montagem saliente. Com um desenho refinado de baixa espessura e com driver interno é ideal para tectos maciços ou sem espaço para encastrar, apresentando um acabamento simples e ordenado. Elevado rendimento e longevidade, baixo encandeamento e iluminação homogénea ao longo da sua superfície são as suas características principais. Possibilidade de funcionamento com solução dimável 1-10V.

The Berna Round line is a range of surface mounted luminaires, in round and square variants. With a refined design of low thickness and with internal driver is ideal for massive ceilings or without space to embed, presenting a simple finish. High performance and longevity, low glare and homogenous illumination along its surface are its main characteristics. Possibility of operation with dimmable solution 1-10V.

La ligne Berna Rond est une gamme de luminaires montées en plafonnier. Avec un design raffiné de basse épaisseur avec driver interne il est idéal pour les plafonniers ou pour l'installation dans un espace restreint, avec une finition simple et uniforme.

De haute performance et de grande longévité, faible éblouissement, un éclairage uniforme au long de sa surface sont ses principales caractéristiques. Intensité variable 1-10V, en option.



Difusor • Diffuser • Diffuseur

PMMA

Lâmpadas • Lamps • Lampes

LED - 3000K / 4000K / 6000K

Acessórios • Accessories • Accessoires

Driver dimável 230V, Regulação 1-10V.
230V Dimmer, Dimmer 1-10V.
Driver réglable 230V, Variateur 1-10V.

Berna R	AxB (mm)	Lumens
6 W	120x40	480 lm
12 W	170x40	1200 lm
18 W	225x40	1590 lm
24 W	300x40	2400 lm

Acabamentos • Finishing • Finition

Berna R	Branco Mate Matt White Blanc Mat			Aço Escovado Polished Steel Acier Brossé		
	3000K	4200K	6000K	3000K	4200K	6000K
6 W	•	•	•	•	•	•
12 W	•	•	•	•	•	•
18 W	•	•	•	•	•	•
24 W	-	•	-	-	-	-

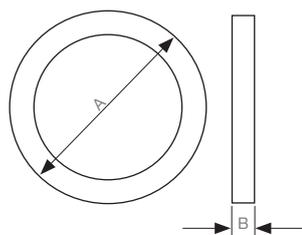

Acabamento • Finishing • Finition



BERNA

Quadrado • Square • Carré

Descrição • Description • Description

A linha Berna Quadrada é uma gama de luminárias de montagem saliente. Com um desenho refinado de baixa espessura e com driver interno é ideal para tectos macios ou sem espaço para encastrar, apresentando um acabamento simples e ordenado. Elevado rendimento e longevidade, baixo encandeamento e iluminação homogénea ao longo da sua superfície são as suas características principais. Possibilidade de funcionamento com solução dimável 1-10V.

The Berna Square line is a range of surface luminaires, in round and square variants. With a refined design of low thickness and with internal driver is ideal for massive ceilings or without space to embed, presenting a simple finish. High performance and longevity, low glare and homogenous illumination along its surface are its main characteristics. Possibility of operation with dimmable solution 1-10V.

La ligne Berna Carré est une gamme de luminaires montées en plafonnier. Avec un design raffiné de basse épaisseur avec driver interne il est idéal pour les plafonniers massifs ou pour l'installation dans un espace restreint, avec une finition simple et ordonnée. De haute performance et de grande longévité, faible éblouissement, un éclairage uniforme le long de sa surface sont ses principales caractéristiques. Intensité variable 1-10V, en option.

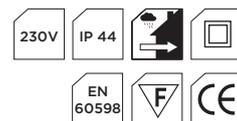

Difusor • Diffuser • Diffuseur

PMMA

Lâmpadas • Lamps • Lampes

LED - 3000K / 4000K / 6000K

Berna Q	AxBxC (mm)	Lumens
6 W	120x120x40	480 lm
12 W	170x170x40	1200 lm
18 W	225x225x40	1590 lm
24 W	300x300x40	2400 lm
36 W	600x300x40	3100 lm
48 W	600x600x40	4000 lm
48 W	1200x300x40	4000 lm

Acessórios • Accessories • Accessoires

Driver dimável 230V, Regulação 1-10V,
Kit de emergência - 36W / 48W.
230V Dimmer, Dimmer 1-10V,
Emergency kit - 36W / 48W,
Driver réglable 230V, Variateur 1-10V,
Eclairage de secours - 36W / 48W.

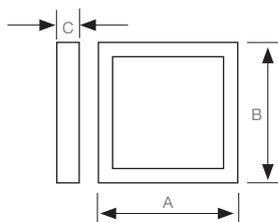

Acabamentos • Finishing • Finition

Berna Q	Branco Mate Matt White Blanc Mat			Aço Escovado Polished Steel Acier Brossé		
	3000K	4200K	6000K	3000K	4200K	6000K
6 W		•			•	
12 W		•			•	
18 W		•			•	
24 W		•			•	
36 W	-	•	-	-	-	-
(600x600) 48 W	-	•	-	-	-	-
(1200x300) 48 W	-	•	-	-	-	-

Acabamento • Finishing • Finition

Aço Escovado
Polished Steel
Acier Brossé
 Branco Mate
Matt White
Blanc Mat

LUPO

Redondo • Round • Rond

Descrição • Description • Description

A linha Lupo Redondo é uma gama de luminárias de design ultrafino. De montagem encastrada, com aba de remate, permite uma fácil integração em qualquer espaço, apresentando um acabamento suave e uniforme. Elevado rendimento e longevidade, baixo encandeamento e iluminação homogênea ao longo da sua superfície são as suas características principais. Possibilidade de funcionamento com solução dimável 1-10V.

The Lupo Round is a range of ultra-thin design luminaires. Recessed mounting with flap mount allows an easy integration into any space, featuring a smooth and even finish. High performance and longevity, low glare and homogenous illumination along its surface are its main characteristics. Possibility of operation with solution dimmable 1-10V.

La ligne Lupo Rond est une gamme de luminaires encastré. Il permet un montage facile dans tout espace, avec une finition simple et uniforme. De haute performance et de grande longévité, faible éblouissement, un éclairage uniforme au long de sa surface sont ses principales caractéristiques. Intensité variable 1-10V, en option.



Difusor • Diffuser • Diffuseur

PMMA

Lâmpadas • Lamps • Lampes

LED - 3000K / 4000K / 6000K

Lupo R	A(mm)	B (mm)	Lumens
5 W	102	97	400 lm
9 W	146	134	900 lm
12 W	170	161	1200 lm
18 W	223	206	1590 lm
20 W	236	225	2000 lm
24 W	300	282	2400 lm

Acessórios • Accessories • Accessoires

Driver dimável 230V, Regulação 1-10V, Kit de emergência - 36W / 48W.
230V Dimmer, Dimmer 1-10V, Emergency kit - 36W / 48W.
Driver réglable 230V, Variateur 1-10V, Eclairage de secours - 36W / 48W.

Acabamentos • Finishing • Finition

Lupo R	Branco Mate Matt White Blanc Mat			Aço Escovado Polished Steel Acier Brossé		
	3000K	4200K	6000K	3000K	4200K	6000K
5 W	•	•	•	•	•	•
9 W	•	•	•	•	•	•
12 W	•	•	•	•	•	•
18 W	•	•	•	•	•	•
20 W	•	•	•	•	•	•
24 W	•	•	•	•	•	•

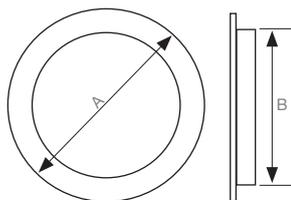

Acabamento • Finishing • Finition



LUPO

Quadrado • Square • Carré

Descrição • Description • Description

A linha Lupo Quadrado é uma gama de luminárias de design ultrafino. De montagem encastrada, com aba de remate, permite uma fácil integração em qualquer espaço, apresentando um acabamento suave e uniforme. Elevado rendimento e longevidade, baixo encadeamento e iluminação homogênea ao longo da sua superfície são as suas características principais. Possibilidade de funcionamento com solução dimável, 1-10V e com kit de emergência.

The Lupo Square is a range of ultra-thin design luminaires. Recessed mounting with flap mount allows an easy integration into any space, featuring a smooth and even finish. High performance and longevity, low glare and homogenous illumination along its surface are its main characteristics. Possibility of operation with solution dimmable 1-10V and with emergency kit.

La ligne Lupo Carré est une gamme de luminaires encastré. Elle permet un montage très facile dans toute espace, avec une finition simple et uniforme. De haute performance et de grande longévité, faible éblouissement, un éclairage uniforme au long de sa surface sont ses principales caractéristiques. Intensité variable 1-10V, en option.

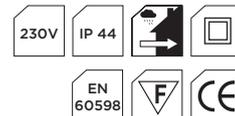

Difusor • Diffuser • Diffuseur

PMMA

Lâmpadas • Lamps • Lampes

LED - 3000K excepto/except/except 36W, 48W
LED - 4200K
LED - 6000K excepto/except/except 36W, 48W

Acessórios • Accessories • Accessoires

Driver dimável 230V, Regulação 1-10V,
Kit de emergência excepto 5W.
230V Dimmer, Dimmer 1-10V,
Emergency kit except 5W.
Driver réglable 230V, Variateur 1-10V,
Eclairage de secours except 5W.

Lupo Q	A (mm)	B (mm)	Lumens
5 W	105x105	97x97	400 lm
9 W	146x146	136x136	900 lm
12 W	170x170	155x155	1200 lm
18 W	223x223	206x206	1590 lm
20 W	236x236	220x200	2000 lm
24 W	300x300	280x280	2400 lm
36 W	300x600	290x590	3200 lm
48 W	600x600	590x590	4300 lm
48 W	1200x300	1190x290	4300 lm

Acabamentos • Finishing • Finition

Lupo Q	Branco Mate Matt White Blanc Mat			Aço Escovado Polished Steel Acier Brossé		
	3000K	4200K	6000K	3000K	4200K	6000K
5 W	•	•	•	•	•	•
9 W	•	•	•	•	•	•
12 W	•	•	•	•	•	•
18 W	•	•	•	•	•	•
20 W	•	•	•	•	•	•
24 W	•	•	•	•	•	•
36 W	-	•	-	-	-	-
48 W	-	•	-	-	-	-
48 W	-	•	-	-	-	-

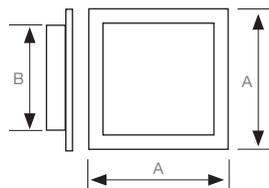

Acabamento • Finishing • Finition

Aço Escovado
Polished Steel
Acier Brossé
 Branco Mate
Matt White
Blanc Mat

SAFIRA

Quadrada • Square • Carré

Descrição • Description • Description

A linha Safira é uma gama de luminárias de baixo perfil, para montagem em tectos Armstrong ou em tectos tipo "T" invertido, permitindo assim uma fácil integração em qualquer espaço, apresentando um acabamento limpo e uniforme. Elevado rendimento e longevidade, baixo encandeamento e iluminação homogénea ao longo da sua superfície são as suas características principais. Possibilidade de funcionamento com solução dimável e com kit de emergência. Em opção pode também ser montado com molas para tectos falsos ou em suspensão.

The Safira Square line is a range of low-profile luminaires, for mounting on Armstrong ceilings or inverted "T" ceilings, allowing an easy integration into any space, presenting a clean and uniform finish. High performance and longevity, low glare and homogenous illumination along its surface are its main characteristics. Possibility of operation with solution and emergency kit. Optionally, it can also be fitted with springs for suspended or suspended ceilings.

La ligne de Safira est une gamme de luminaires à bas profil, pour le montage dans les plafonds Armstrong ou des plafonds de type "T", ce qui permet un montage facile dans toute pièce, avec une finition lisse et uniforme. Haute efficacité et la longévité, faible éblouissement, un éclairage uniforme le long de sa surface sont ses principales caractéristiques. Opération avec une solution de dimável et éclairage de secours.



Safira	A (mm)	B (mm)	Lumens
600x600 48 W	595x595	9	4300 lm
1200x300 48 W	1195x295	9	4300 lm

Difusor • Diffuser • Diffuseur

PMMA

Montagem • Mount • Monture

Safira	Armstrong - Tectos Armstrong - Ceiling Armstrong - Plafond	Molas Springs Ressorts	Suspensão Suspended Suspendu
600x600 48 W	•	○	○
1200x300 48 W	•	○	○

○ - Opcional / Optional / En option

Lâmpadas • Lamps • Lampes

LED - 4200K / LED 6000K apenas 600x600
LED - 4200K / LED 6000K only 600x600
LED - 4200K / LED 6000K uniquement 600x600

Acessórios • Accessories • Accessoires

Regulação 1-10V.
Dimmer 1-10V.
Variable 1-10V.

Acabamento • Finishing • Finition

Branco Mate
 Matt White
 Blanc Mat

Alumínio - apenas 600x600
 Aluminum - only 600x600
 Aluminum - seulement 600x600

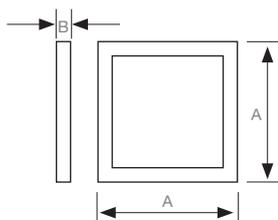

AXA

Redondo/Quadrado • Round/Square • Rond/Carré

Descrição • Description • Description

A linha Axa é uma gama de luminárias de montagem encastrada com aba de remate que permite uma fácil integração em qualquer espaço, nas variantes redonda e quadrada. Com um formato parabólico e revestido com um composto branco, permite assim a inexistência de encandeamento e uma iluminação homogênea e suave. Elevado rendimento e longevidade, ideal para utilização em ambientes hospitalares, escolas, clínicas, consultórios médicos.

The Axa line is a range of recessed mounting luminaires with a back flap that allows easy integration into any space, in the round and square variants.

Parabolic format and coated with a white composite, it allows the absence of glare and a homogenous and smooth illumination. High efficiency and longevity, ideal for use in hospital environments, schools, clinics, doctors' offices.

Ligne Axa est une gamme d'appareils qui permet un montage très facile dans toutes pièces, en versions ronde et carrée. Avec un diffuseur parabolique et un composite blanc, il permet l'absence d'éblouissement et un éclairage homogène et uniforme.

Haut rendement et grande longévité, idéal pour une utilisation dans les hôpitaux, les écoles, les cliniques, et bureaux.

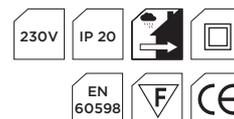

Difusor • Diffuser • Diffuseur

Acrílico
Acrylic
Acrylique

Lâmpadas • Lamps • Lampes

LED - 6000K / LED 4200K apenas 12W
LED - 6000K / LED 4200K only 12W
LED - 6000K / LED 4200K uniquement 12W

Redondo • Round • Rond

Axa R	A (mm)	B (mm)	C (mm)	Lumens
6 W	106	97	36	500 lm
12 W	146	136	46	1080 lm

Quadrado • Square • Carré

Axa Q	A (mm)	B (mm)	C (mm)	Lumens
6 W	110x110	97x97	30	500 lm
12 W	155x155	136x136	46	1080 lm

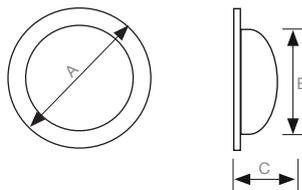
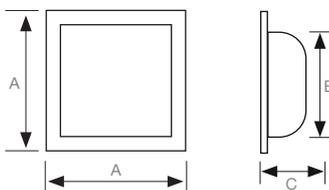

Acabamento • Finishing • Finition

■ Branco Mate
Matt White
Blanc Mat

ELLO

Redondo • Round • Rond

Descrição • Description • Description

A linha Ello é uma gama de luminárias com placa de led, de montagem encastrada, com aba de remate que permite uma fácil integração em qualquer espaço, apresentando um acabamento suave e uniforme.

Elevado rendimento e longevidade, baixo encandeamento e iluminação homogénea ao longo da sua superfície são as suas características principais.

Ideal para utilização em espaços comerciais. Possibilidade de funcionamento com solução dimável.

The Ello line is a range of luminaires with led plate, recessed mounting, with back flap that allows easy integration in any space, presenting a smooth and uniform finish. High performance and longevity, low chalking and homogenous illumination along its surface are its main characteristics.

Ideal for use in commercial spaces. Possibility of operation in dimmable solution.

La ligne Ello est une gamme de luminaires avec PCB led, montage encastré, permet un montage facile dans toutes pieces, avec une finition uniforme et lisse.

Haute efficacité et grande longévité, faible éblouissement, un éclairage uniforme le long de sa surface sont ses principales caractéristiques.

Idéal pour une utilisation dans les espaces commerciaux.

Intensité variable 1-10V, en option.



Difusor • Diffuser • Diffuseur

Acrílico
Acrylic
Acrylique

Lâmpadas • Lamps • Lampes

LED - 4200K

Ello R	A (mm)	B (mm)	C (mm)	Lumens
7 W	90	75	30	720 lm
12 W	120	105	30	1230 lm
24 W	170	155	30	2570 lm
32 W	225	205	30	3360 lm

Acessórios • Accessories • Accessoires

Regulação 1-10V.
Dimmer 1-10V.
Réglabe 1-10V.

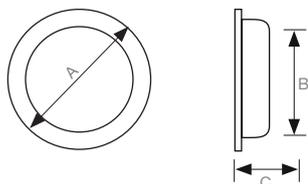

Acabamento • Finishing • Finition

Branco Mate
Matt White
Blanc Mat



VENEZA

Redondo • Round • Rond

Descrição • Description • Description

A linha Veneza é uma gama de luminárias com led Cob, de montagem encastrada, com aba de remate que permite uma fácil integração em qualquer espaço, apresentando um acabamento suave e uniforme.

Elevado rendimento e longevidade, baixo encandeamento e iluminação homogênea ao longo da sua superfície são as suas características principais.

A distância focal entre o led e o difusor, permite uma significativa redução de encandeamento, que o torna num produto ideal para utilização em espaços comerciais. Disponível nas potências de 15W, 25W e 40W.

The Veneza line is a range of luminaires with led Cob, recessed mounting, with flap that allows easy integration in any space, presenting a smooth and uniform finish. High performance and longevity, low chaining and homogenous illumination along its surface are its main characteristics.

The focal length between the led and the diffuser allows a significant reduction of glare, which makes it an ideal product for use in commercial spaces.

Available in powers of 15W, 25W and 40W.

La ligne de Venisa est une gamme de luminaires avec led Cob de montage encastré, qui permet un montage facile dans toutes pieces, avec une surface lisse et uniforme.

Haute efficacité et la longévité, faible éblouissement, un éclairage uniforme le long de sa surface sont ses principales caractéristiques.

La distance focale entre les led et le diffuseur permet une réduction significative de l'éblouissement, ce qui en fait un produit idéal pour une utilisation dans les zones commerciales.

Disponibile en puissances de 15W, 25W et 40W.



Veneza R	A (mm)	B (mm)	C (mm)	Lumens
15 W	120	92	62	1650 lm
25 W	159	130	80	2750 lm
40 W	220	188	100	4400 lm

Difusor • Diffuser • Diffuseur

Lente 60°
60° Lens
Lentilles 60°

Acabamento • Finishing • Finition

Branco Mate
Matt White
Blanc Mat

Lâmpadas • Lamps • Lampes

LED - 4200K

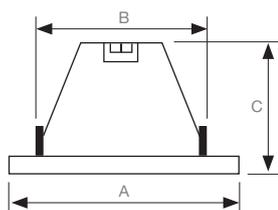

BERNA

Acrílico • Acrylic • Acrylique

Descrição • Description • Description

A linha Berna Acrílico é uma gama de luminárias de montagem saliente, nas variantes redonda e quadrada. Composta por estrutura em alumínio e difusor fosco é ideal para tectos maciços ou sem espaço para encastrar, apresentando um acabamento simples e ordenado. Elevado rendimento e longevidade, baixo encandeamento e iluminação homogénea ao longo da sua superfície são as suas características principais. Ideal para espaços comuns em prédios e espaços comerciais.

The Berna Acrylic line is a range of surface mounted luminaires, in round and square variants. Composed of aluminum structure and frost diffuser is ideal for massive ceilings or without space to embed, presenting a simple and orderly finish. High performance and longevity, low chalking and homogenous illumination along its surface are its main characteristics. Ideal for buildings common spaces in and commercial spaces.

La ligne Berna Acrylique est une gamme de luminaires montées en plafonnier, en versions ronde et carrée. Composé d'un cadre en aluminium et de diffuseur opaline est idéal pour les plafonniers ou pour l'installation dans un espace restreint, avec une finition simple et uniforme. Haute efficacité et la longévité, faible éblouissement, un éclairage uniforme le long de sa surface sont ses principales caractéristiques. Idéal pour les zones communes et les espaces commerciaux.

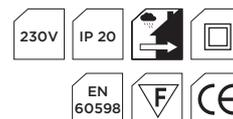

Difusor • Diffuser • Diffuseur

PVC

Lâmpadas • Lamps • Lampes

LED - 6000K

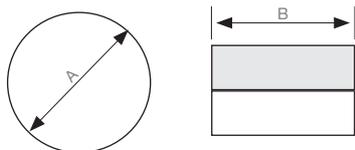
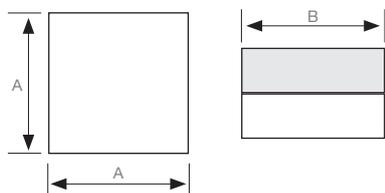

Redondo • Round • Rond

Berna R	A (mm)	B (mm)	Lumens
12 W	120	120	960 lm
18 W	180	180	1440 lm
24 W	220	220	1950 lm

Quadrado • Square • Carré

Berna Q	A (mm)	B (mm)	Lumens
12 W	120	120	960 lm
18 W	180	180	1440 lm
24 W	220	220	1950 lm

Acabamento • Finishing • Finition

Branco Mate
Matt White
Blanc Mat

NUMI

Descrição • Description • Description

A linha Numi é uma gama de luminárias de montagem saliente, com um formato de meia lua, o que lhe permite a utilização numa multiplicidade de espaços.

Elevado rendimento e longevidade, baixo encandeamento e iluminação homogénea ao longo da sua superfície são as suas características principais.

Ideal para espaços comuns em prédios e comerciais.

The Numi line is a range of surface luminaires in a half moon shape, which allows it to be used in a multitude of spaces. High performance and longevity, low glare and homogenous illumination along its surface are its main characteristics. Ideal for buildings common spaces and commercial spaces.

La ligne Numi est une gamme de luminaires montées en plafonnier, en forme de demi-lune, qui vous permet d'utiliser une variété d'espaces.

Haute efficacité et la longévité, faible éblouissement, un éclairage uniforme le long de sa surface sont ses principales caractéristiques.

Idéal pour les zones communes dans les bâtiments et espaces commerciaux.



Difusor • Diffuser • Diffuseur

PVC

Lâmpadas • Lamps • Lampes

LED 9W - 4000K

Numi	A (mm)	B (mm)	C (mm)	Lumens
9 W	115	225	22	700 lm

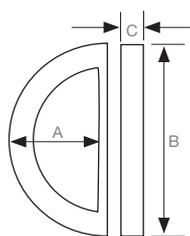

Acabamento • Finishing • Finition

- Branco Mate
Matt White
Blanc Mat
- Oxidado
Rusty Brass
Métal Rouillé

VEGA

Descrição • Description • Description

A linha Vega é uma gama de luminárias redonda de montagem saliente. Composta por difusor fosco, ideal para tectos maciços ou sem espaço para encastar, apresentando um acabamento simples e ordenado.

Elevado rendimento e longevidade, baixo encandeamento e iluminação homogénea ao longo da sua superfície são as suas características principais.

Ideal para caixas de escadas, condomínios, áreas comuns em prédios e áreas comerciais.

The Vega line is a range of round surface mounting luminaires. Composed with frosted diffuser, ideal for massive ceilings or without space to embed, presenting a simple and orderly finish. High performance and longevity, low churning and homogenous illumination along its surface are its main characteristics. Ideal for stair boxes, condos, common areas in buildings and commercial areas.

La ligne Vega est une gamme de luminaires rondes pour montage exclusif sur plafonnier. Composé d'un diffuseur opaline, idéal pour les plafonniers ou pour pour l'installation en espaces restreint, avec une finition simple et uniforme.

Haute efficacité et la longévité, faible éblouissement, un éclairage uniforme le long de sa surface sont ses principales caractéristiques.

Idéal pour l'éclairage des escalier, des zones communes dans les bâtiments et zones commercial.



Difusor • Diffuser • Diffuseur

PVC

Vega	A (mm)	B (mm)	Lumens
12 W	255	75	960 lm
24 W	330	95	1920 lm

Lâmpadas • Lamps • Lampes

LED 12W / 24W - 4000K

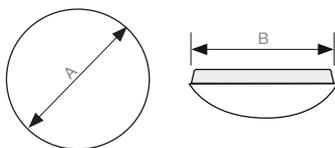

Acabamento • Finishing • Finition

Branco Mate
Matt White
Blanc Mat

CORVO LED

Descrição • Description • Description

Downlight redondo, orientável na horizontal $\pm 330^\circ$ na vertical $\pm 45^\circ$ que permite utilizar em diferentes conceitos de iluminação para os mesmos espaços.

Corpo em alumínio com difusor em vidro temperado transparente.

Round downlight, horizontally adjustable $\pm 330^\circ$ vertically $\pm 45^\circ$ that allows to use in different illumination concepts for the same spaces.

Aluminum body with transparent tempered glass diffuser.

Downlight rond, réglable horizontalement $\pm 330^\circ$ et verticalement $\pm 45^\circ$ qui permet une utilisation dans différents concepts d'éclairage pour les mêmes espaces.

Corps en aluminium avec un diffuseur en verre trempé transparent.



Difusor • Diffuser • Diffuseur

Vidro Temperado Transparente
Clear Tempered Glass
Verre Trempé Clair

Lâmpadas • Lamps • Lampes

LED 10W - 4000K

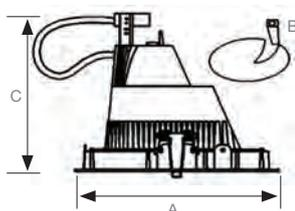

Corvo LED	A (mm)	B (mm)	C (mm)	Lumens
10 W	188	176	180	1050 lm

Acabamento • Finishing • Finition

Branco Mate
Matt White
Blanc Mat



ZETO LED

Descrição • Description • Description

O projector Zeto led é uma luminária rectangular orientável até 45°, de montagem encastrada, com aba de remate, que permite uma fácil integração em qualquer espaço, apresentando um acabamento suave e uniforme. Com difusor transparente e zona frontal ao led em fosco, elimina assim a possibilidade de encandeamento.

The Zeto led is a 45° rectangular orientable downlight, recessed luminaire with recessed mounting flap that allows an easy integration into any space with a smooth and even finish. With transparent diffuser and Matt zone in front of led, eliminates the possibility of glare.

Le projecteur Zeto led est une luminaire rectangulaire avec réglable à 45°, en montage encastré, ce qui permet un montage facile dans tout espace, avec une surface lisse et uniforme. Avec diffuseur transparent et la partie frontal du led en finition mat, éliminant ainsi l'éblouissement.



Difusor • Diffuser • Diffuseur

Vidro Temperado Transparente
Clear Tempered Glass
Verre Trempé Clair



Lâmpadas • Lamps • Lampes

LED SMD 30w - 4200K

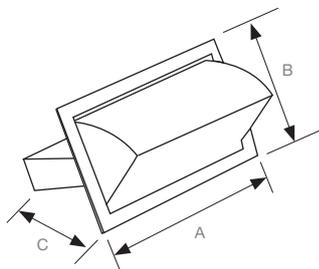

Zeto LED	A (mm)	B (mm)	C (mm)	Lumens
30 W	235	123	104	3150 lm

Acabamento • Finishing • Finition

Branco Mate
Matt White
Blanc Mat



STORE FOCUS

Descrição • Description • Description

Esta gama baseia-se em projectores de calha em led, para uma ampla utilização em espaços comerciais assim como galerias, de instalação fácil e versátil pois permite múltiplas configurações mediante as necessidades de iluminação.

This range is based on electric rail led projectors, for wide use in commercial spaces as well as galleries, with easy and versatile installation as it allows multiple configurations by lighting needs.

Cette gamme est basée sur projecteurs led tracklight, pour une utilisation pour grandes surfaces commerciaux ainsi que les galeries, permet une installation polyvalente et facile, car il permet de multiples configurations sur les exigences d'éclairage.

Difusor • Diffuser • Diffuseur

Lente 30°
30° Lens
Lentilles 30°

Lâmpadas • Lamps • Lampes

LED 30W - 3000K / 4000K

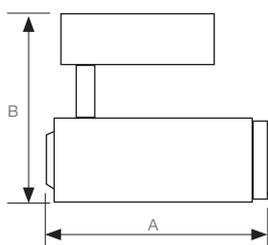

Store Focus	A (mm)	B (mm)	Lumens
30 W	125	180	2700 lm

Acabamento • Finishing • Finition

 Branco Mate Matt White Blanc Mat	 Preto Mate Matt Black Noir Mat
--	--



LIGHTLENS I / II

Descrição • Description • Description

Esta gama baseia-se num projector técnico, com lente de aumento, para uma utilização em trabalhos que requerem maior detalhe. Instalação fácil e versátil, pois, permite múltiplas configurações mediante as necessidades de iluminação. Ideal para utilização em ourivesarias e salões de estética. Fixação por base de mesa ou por clip de aperto.

This range is based on a technical projector, with magnifying glass, for use in jobs that require more detail. Easy and versatile installation, therefore, allows multiple configurations by lighting needs. Ideal for use in goldsmiths and beauty salons. Fixing by table base or by clamping clip.

Cette gamme est basée sur un projecteur technique avec loupe intégrée, pour une utilisation dans les emplois qui exigent plus de détail, avec installation facile et polyvalent permettant donc de multiples configurations sur les besoins d'éclairage. Idéal pour une utilisation pour les orfèvres et salons de beauté. Fixation sur la base de table ou par clip de serrage.

Difusor • Diffuser • Diffuseur

Lupa
Magnifying glass
Lentille

Lâmpadas • Lamps • Lampes

LED 4000K

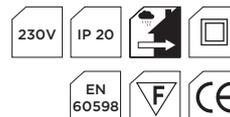

LightLens	W	A (mm)	B (mm)	Lumens
I	6 W	10	350	560 lm
II	6 W	10	300	560 lm

Acabamento • Finishing • Finition

Branco Mate
Matt White
Blanc Mat

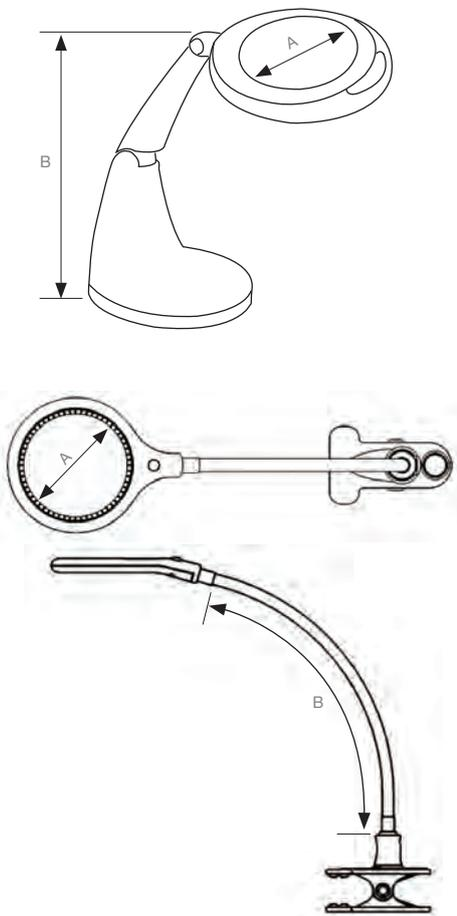

Interior Saliente/Encastrar

*Indoor
Surface/Recessed*

*Interieur
Plafonnier/Encastré*



Aqua

πάγ. 56

Demo

πάγ. 54

Giani

πάγ. 53

Kleo

πάγ. 56

Leda

πάγ. 52

Lumi

πάγ. 57

Lupi

πάγ. 57

Lyca

πάγ. 54

Magnum

πάγ. 55

Modular

πάγ. 58

Modular II

πάγ. 59

Nico

πάγ. 55

Primus

πάγ. 59

Primus Trio

πάγ. 60

Quadra

πάγ. 52

Villa

πάγ. 60

LEDA

Descrição • Description • Description

Luminária para aplicação saliente no tecto, ideal para áreas comuns quer em ambiente doméstico ou empresarial. Corpo em alumínio, difusor em vidro temperado transparente, com possibilidade vários suportes.

Surface ceiling-mounted luminaire, ideal for common areas whether in homes or business environment. Aluminum body, and transparent tempered glass diffuser. Several supports available.

Luminaire pour application en plafonnier, idéal pour les zones communes ou dans la maison ou le bureaux.

Corps en aluminium, diffuseur en verre trempé transparent, avec possibilité de divers type de supports.

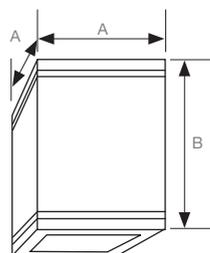

Difusor • Difuser • Diffuseur

Vidro Temperado Transparente
Clear Tempered Glass
Verre Trempé Clair

	A (mm)	B (mm)
Leda	108	135

Lâmpadas • Lamps • Lampes

Suporte - E27 / GU10
Lamp Holder - E27 / GU10
Type de Culot - E27 / GU10

Acabamento • Finishing • Finition

Alumínio Mate
Matt Aluminium
Aluminium Mat



QUADRA

Descrição • Description • Description

Luminária para aplicação saliente no tecto, ideal para áreas comuns quer em ambiente doméstico ou empresarial. Corpo e acabamento em alumínio, com suporte GU10.

Surface mounted luminaire, ideal for common areas whether in homes or business environments. Aluminium body, with GU10 lamp holder.

Luminaires pour plafonnier, idéale pour zones communes, que ce soit en milieu familial ou professionnel. Construit en aluminium et développé avec haute efficacité énergétique led technologie, support GU10.

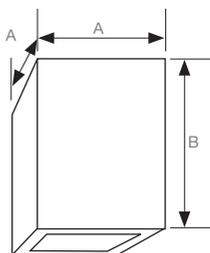

Difusor • Difuser • Diffuseur

Sem Difusor
Without Diffuser
Sans Diffuseur

	A (mm)	B (mm)
Quadra	75	100

Lâmpadas • Lamps • Lampes

Suporte - GU10
Lamp Holder - GU10
Type de Culot - GU10

Acabamento • Finishing • Finition

Alumínio Mate
Matt Aluminium
Aluminium Mat

Preto Mate
Black Matt
Noir Mat

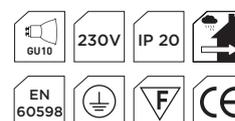

*Outras cores a pedido
Other colours on request
Autres couleurs sur commande

GIANI

Descrição • Description • Description

Gama de downlights salientes redondos e quadrados, ideal para áreas comuns quer em ambiente doméstico ou empresarial. Construídos em alumínio para aplicação saliente no tecto e desenvolvido com tecnologia led de elevada eficiência energética.

Range of round and square surface mounted luminaires, ideal for common areas whether in home or business environment. Constructed in aluminum and developed with high energy efficiency led technology.

Gamme de luminaires ronde pour plafonnier, idéale pour zones communes, que ce soit en milieu familial ou professionnel. Construit en aluminium et développé avec haute efficacité énergétique led technologie.

Difusor • Difuser • Diffuseur

Acrílico
Acrylic
Acrylique

Lâmpadas • Lamps • Lampes

LED 12W/30W - 4200K



Redondo • Round • Rond

Giani R	A (mm)	B (mm)	Lumens
12 W	110	125	960 lm
30 W	170	185	2400 lm

Quadrado • Square • Carré

Giani Q	A (mm)	B (mm)	Lumens
12 W	110	125	960 lm
30 W	160	165	2400 lm

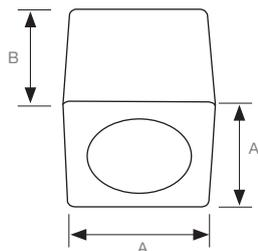
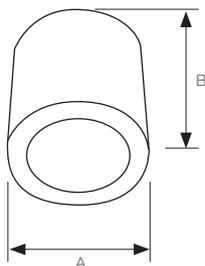

Acabamento • Finishing • Finition

Branco Mate
Matt White
Blanc Mat

LYCA

Descrição • Description • Description

Luminária para aplicação saliente no tecto, ideal para áreas comuns quer em ambiente doméstico ou empresarial. Corpo e acabamento em alumínio, com suporte GU10.

Surface mounted luminaire, ideal for common areas whether in homes or business environments.

Luminaires pour plafonnier, idéale pour zones communes, que ce soit en milieu familial ou professionnel. Construit en aluminium et développé avec haute efficacité énergétique LED technologie, support GU10.

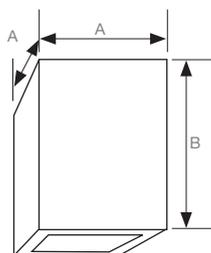

Difusor • Difuser • Diffuseur

Sem Difusor
Without Diffuser
Sans Diffuseur

	A (mm)	B (mm)
Lyca	80	90

Lâmpadas • Lamps • Lampes

Suporte - GU10
Lamp Holder - GU10
Type de Culot - GU10

Acabamento • Finishing • Finition

Alumínio Natural
Natural Aluminium
Aluminium Naturel

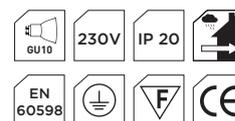

DEMO

Descrição • Description • Description

Spot light de design arrojado, construído em alumínio torneado e acabamento em alumínio natural.

Spot light built in aluminium with bold design and natural aluminium finish.

Spot light en aluminium avec design audacieux et finition en aluminium naturel.

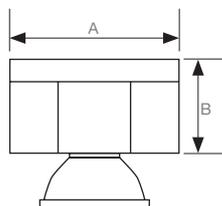

Difusor • Difuser • Diffuseur

Sem Difusor
Without Diffuser
Sans Diffuseur

	A (mm)	B (mm)
Demo	78	43

Lâmpadas • Lamps • Lampes

Suporte - GU10
Lamp Holder - GU10
Type de Culot - GU10

Acabamento • Finishing • Finition

Alumínio Natural
Natural Aluminium
Aluminium Naturel

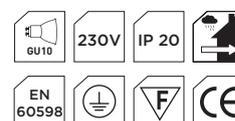

NICO

Descrição • Description • Description

O spotlight Nico é uma luminária redonda de montagem encastrada, com aba de remate, que permite uma fácil integração em qualquer espaço, apresentando um acabamento suave e uniforme.

Elevado rendimento e longevidade, acabamento em branco ou aço escovado, vidro de protecção e iluminação homogénea são as suas características principais.

The Nico spotlight is a round-mount recessed luminaire that allows an easy integration into any space with a smooth and even finish. High performance and longevity, white or brushed steel finish, protective glass and homogenous illumination are its main characteristic.

Le projecteur Nico est un luminaire encastré à montage rond qui permet une intégration facile dans n'importe quel espace avec une finition lisse et uniforme. Haute performance et longévité, finition en acier brossé ou blanc, verre de protection et éclairage homogène sont ses principales caractéristiques.



	A (mm)	B (mm)	C (mm)	Lumens
Nico	85	54	75	400 lm

Difusor • Difuser • Diffuseur

Vidro Temperado Transparente
Clear Tempered Glass
Verre Trempé Clair

Acabamento • Finishing • Finition

Branco Mate
Matt White
Blanc Mat

Aço Escovado
Polished Steel
Acier Brossé



Lâmpadas • Lamps • Lampes

LED 5W 4200K

MAGNUM

Descrição • Description • Description

Luminária em alumínio, com acabamento em alumínio natural de aplicação encastrada, equipado com três led permitindo assim um feixe de luz mais definido.

Para interiores em aplicações onde se pretende iluminação de realce sobre determinada área.

Luminaire in aluminum, with natural aluminum finish for recessed application, equipped with three leds allowing a more defined light beam. For applications where highlight lighting is desired.

Luminaire en aluminium, avec finition en aluminium naturel pour application encastrée, équipé de trois led permettant un faisceau lumineux plus défini. Pour les applications intérieures où vous souhaitez accentuer l'éclairage sur une surface en particulier.



	A (mm)	B (mm)	C (mm)	Lumens
Magnum	74	23	63	400 lm

Difusor • Difuser • Diffuseur

PMMA

Acabamento • Finishing • Finition

Alumínio Natural
Natural Aluminium
Aluminium Naturel



Lâmpadas • Lamps • Lampes

3 LEDs 1W - 6000K

AQUA

Descrição • Description • Description

Aro redondo em alumínio, com acabamento em alumínio natural, orientável de montagem encastrada.

Produto versátil que permite a utilização de vários tipos de suportes de lâmpada.

Round aluminum ring, with natural aluminum finish, adjustable flush mount. Versatile product that allows the use of various types of lamp holders.

Cadre en aluminium rond, réglable pour montage encastré.

Produit polyvalent qui permet l'utilisation de différents types de supports de lampe.

Difusor • Difuser • Diffuseur

Orientável
Adjustable
Réglable

Lâmpadas • Lamps • Lampes

Suporte - GU10 / MR16
Lamp Holder - GU10 / MR16
Type de Culot - GU10 / MR16

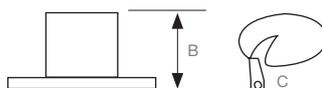
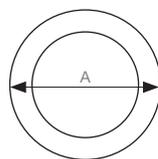

A (mm) B (mm) C (mm)

A (mm)	B (mm)	C (mm)	
Aqua	93	26	80

Acabamento • Finishing • Finition

Alumínio
Aluminium
Aluminium

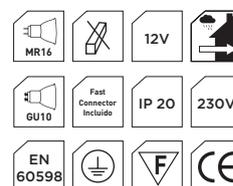

KLEO

Descrição • Description • Description

Aro quadrado em alumínio, orientável de montagem encastrada.

Produto versátil que permite a utilização de vários tipos de suportes de lâmpada.

Square aluminum ring, adjustable flush mounting.

Versatile product that allows the use of various types of lamp holders.

Cadre en aluminium carré, réglable pour montage encastré.

produit polyvalent qui permet l'utilisation de différents types de supports de lampe.

Difusor • Difuser • Diffuseur

Orientável
Adjustable
Réglable

Lâmpadas • Lamps • Lampes

Suporte - GU10 / MR16
Lamp Holder - GU10 / MR16
Type de Culot - GU10 / MR16

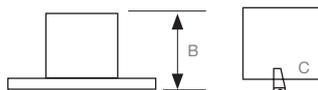
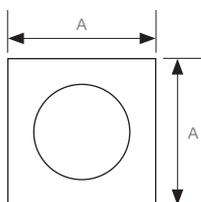

A (mm) B (mm) C (mm)

A (mm)	B (mm)	C (mm)	
Kleo	90	53	81

Acabamento • Finishing • Finition

Branco Mate
Matt White
Blanc Mat

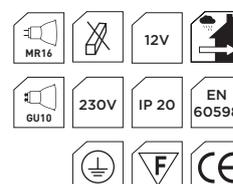

LUMI

Descrição • Description • Description

Aro redondo em alumínio injectado, com acabamento em alumínio mate, orientável de montagem encastrada.
 Produto versátil que permite a utilização de vários tipos de suportes de lâmpada.

Injected aluminum round ring, with matt aluminum finish, adjustable recessed mounting. Versatile product that allows the use of various types of lamp holders.

Cadre rond en aluminium injecté, avec finition en aluminium mat, montage encastré réglable. Produit polyvalent qui permet l'utilisation de divers types de culot.

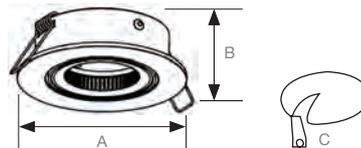

Lâmpadas • Lamps • Lampes

Suporte - GU10 / MR16
 Lamp Holder - GU10 / MR16
 Type de Culot - GU10 / MR16

	A (mm)	B (mm)	C (mm)
Lumi	82	33	69

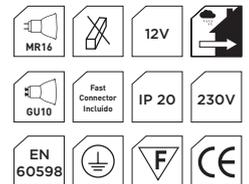

Acabamento • Finishing • Finition

Alumínio Mate
 Matt Aluminium
 Aluminium Mat

LUPI

Descrição • Description • Description

Aro redondo em alumínio, com acabamento em alumínio natural, de montagem encastrada.
 Produto versátil que permite a utilização de vários tipos de suportes de lâmpada.

Round aluminum ring, with natural aluminum finish, recessed mounting. Versatile product that allows the use of various types of lamp holders.

Cadre rond en aluminium, finition en aluminium naturel, montage encastré. Produit polyvalent qui permet l'utilisation de divers types de culot.

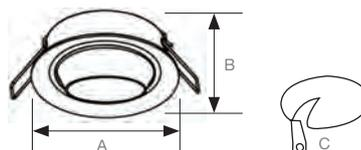

Lâmpadas • Lamps • Lampes

Suporte - GU10 / MR16
 Lamp Holder - GU10 / MR16
 Type de Culot - GU10 / MR16

	A (mm)	B (mm)	C (mm)
Lupi	83	40	72

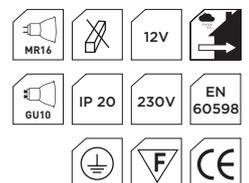

Acabamento • Finishing • Finition

Alumínio Natural
 Natural Aluminium
 Aluminium Natural

MODULAR

Descrição • Description • Description

Aro quadrado simples, orientável, com corpo em chapa de ferro, para montagem encastrada.
Ideal para uma iluminação direcionada em espaços comerciais.

*Single square ring, adjustable, with iron plate body, for recessed mounting.
Ideal for targeted lighting in commercial spaces.*

*Cadre carrée simple, réglable, avec corps en fer, pour montage encastré.
Idéal pour l'éclairage ciblé dans les espaces commerciaux.*

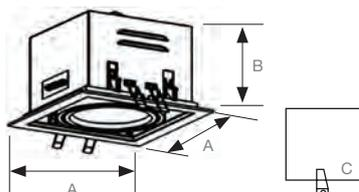

Difusor • Difuser • Diffuseur

Orientável
Adjustable
Réglable

A (mm) B (mm) C (mm)

	A (mm)	B (mm)	C (mm)
Modular	190	80	165

Lâmpadas • Lamps • Lampes

Suporte - GU10 LED / AR111 / AR111 LED
Lamp Holder - GU10 LED / AR111 / AR111 LED
Type de Culot - GU10 LED / AR111 / AR111 LED

Acabamento • Finishing • Finition

Alumínio
Aluminium
Aluminium

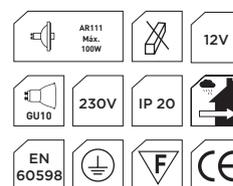

MODULAR II

Descrição • Description • Description

Aro quadrado duplo, orientável, com corpo em chapa de ferro, para montagem encastrada.
Ideal para uma iluminação direccional em espaços comerciais.

Double square ring, adjustable, with iron plate body, for recessed mounting. Ideal for targeted lighting in commercial spaces.

Double carré, réglable, avec corps en fer, pour montage encastré. Idéal pour l'éclairage ciblé dans les espaces commerciaux.

Difusor • Difuser • Diffuseur

Orientável
Adjustable
Réglable

Lâmpadas • Lamps • Lampes

Suporte - GU10 LED / AR111 / AR111 LED
Lamp Holder - GU10 LED / AR111 / AR111 LED
Type de Culot - GU10 LED / AR111 / AR111 LED

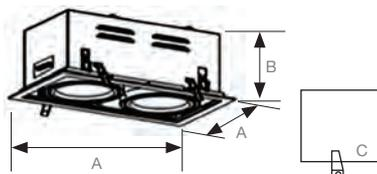

	A (mm)	B (mm)	C (mm)
Modular II	190x340	80	165x310

Acabamento • Finishing • Finition

Alumínio
Aluminium
Aluminium

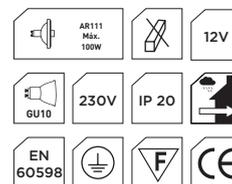

PRIMUS

Descrição • Description • Description

O Primus é um aro quadrado em alumínio puro, com acabamento em alumínio natural, e orientável.
Produto versátil que permite a utilização de vários tipos de suportes de lâmpada.

The Primus is a square ring in pure aluminium, with natural aluminium finish, and adjustable. Versatile product that allows the use of various types of lamp holders.

Le Primus est un cadre carré en aluminium, avec finition en aluminium naturel, et réglable. Produit polyvalent qui permet l'utilisation de divers types culot de lampe.

Difusor • Difuser • Diffuseur

Orientável
Adjustable
Réglable

Lâmpadas • Lamps • Lampes

Suporte - GU10 / MR16
Lamp Holder - GU10 / MR16
Type de Culot - GU10 / MR16

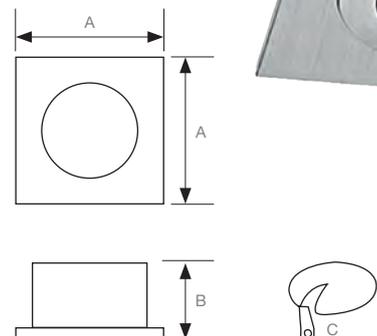

	A (mm)	B (mm)	C (mm)
Primus	93	60	80

Acabamento • Finishing • Finition

Alumínio Natural
Natural Aluminium
Aluminium Natural

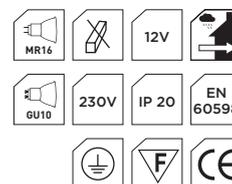

PRIMUS TRIO

Descrição • Description • Description

O Primus Trio é um aro rectangular em alumínio puro, com acabamento em alumínio natural, e orientável.
Produto versátil que permite a utilização de vários tipos de suportes de lâmpada.

*The Primus Trio is a rectangle ring in pure aluminum, with natural aluminum finish, and adjustable.
Versatile product that allows the use of various types of lamp holders.*

Le Primus Trio est un cadre rectangle en aluminium pur, avec finition en aluminium naturel, et réglable.

Produit polyvalent qui permet l'utilisation de divers types de culot de lampes.

Difusor • Difuser • Diffuseur

Orientável
Adjustable
Réglable

Lâmpadas • Lamps • Lampes

Suporte - 3xGU10 / 3xMR16
Lamp Holder - 3xGU10 / 3xMR16
Type de Culot - 3xGU10 / 3xMR16

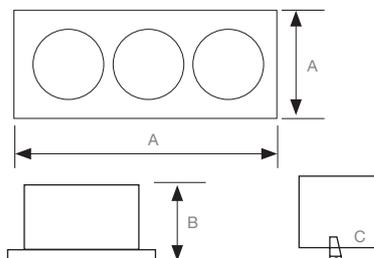

	A (mm)	B (mm)	C (mm)
Primus Trio	93x253	60	80x245

Acabamento • Finishing • Finition

Alumínio Natural
Natural Aluminium
Aluminium Naturel

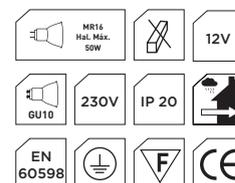

VILLA

Descrição • Description • Description

Aro redondo em alumínio injectado, orientável em 30°.
Produto versátil que permite a utilização de vários tipos de suportes de lâmpada.

*Injected aluminum round ring, adjustable by 30°.
Versatile product that allows the use of various types of lamp holders.*

*Cadre rond en aluminium injecté réglable de 30°.
Produit polyvalent qui permet l'utilisation de divers types de culot de lampes.*

Difusor • Difuser • Diffuseur

Orientável 30°
Adjustable 30°
Adjustable 30°

Lâmpadas • Lamps • Lampes

Suporte - GU10 / MR16
Lamp Holder - GU10 / MR16
Type de Culot - GU10 / MR16

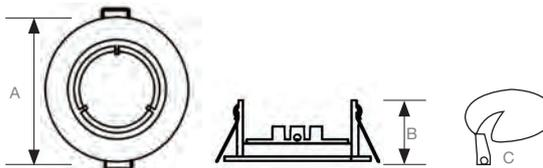

	A (mm)	B (mm)	C (mm)
Villa	95	32,5	80

Acabamento • Finishing • Finition

Branco Mate
Matt White
Blanc Mat

Alumínio
Aluminium
Aluminium

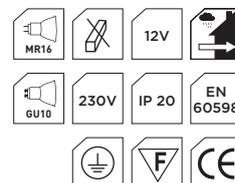



Exterior Parede

Exterior Wall

Mural Extérieur



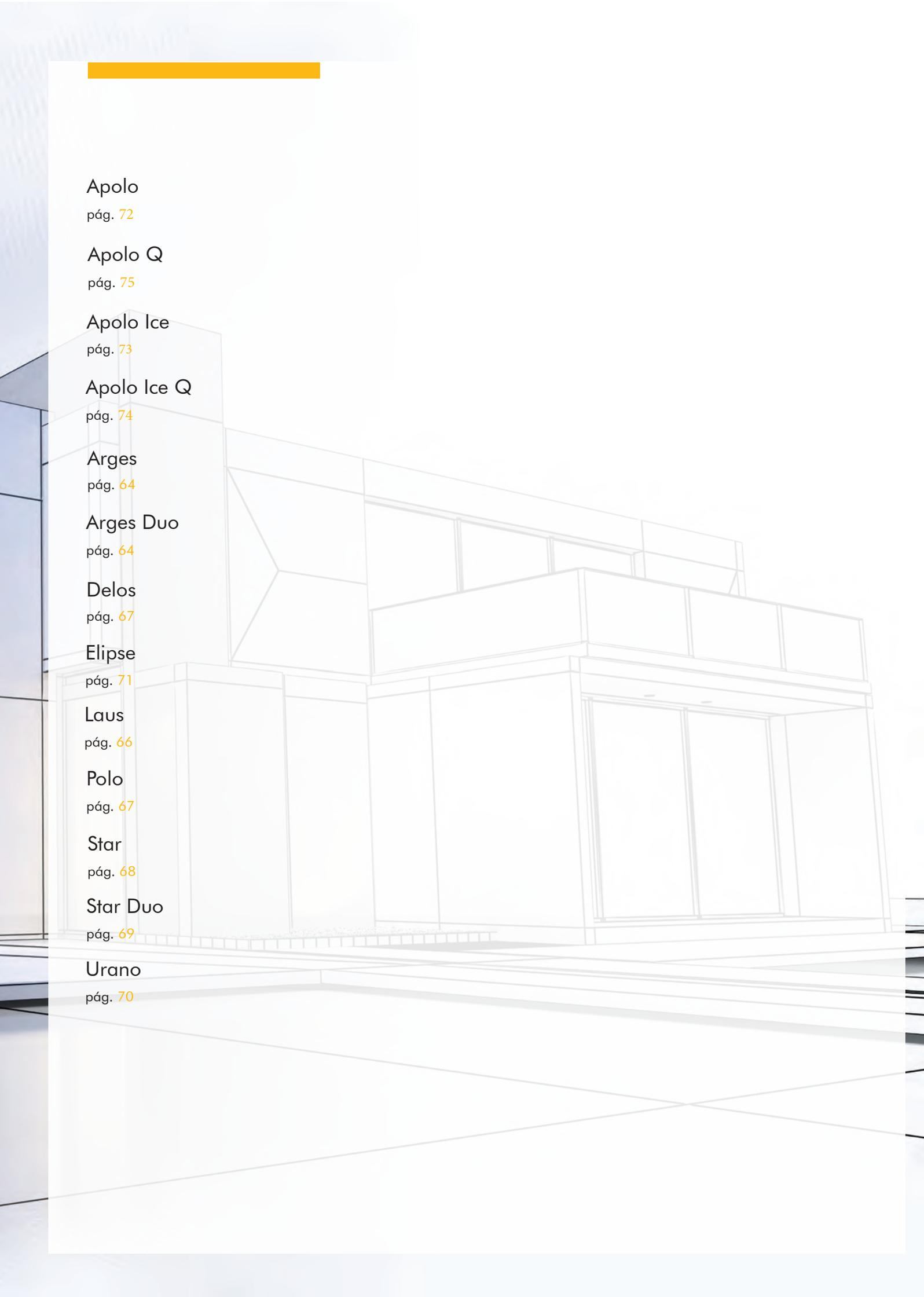

Apolo

πάγ. 72

Apolo Q

πάγ. 75

Apolo Ice

πάγ. 73

Apolo Ice Q

πάγ. 74

Arges

πάγ. 64

Arges Duo

πάγ. 64

Delos

πάγ. 67

Elipse

πάγ. 71

Laus

πάγ. 66

Polo

πάγ. 67

Star

πάγ. 68

Star Duo

πάγ. 69

Urano

πάγ. 70

ARGES

Descrição • Description • Description

Aplique de parede, ideal para varrimento de paredes/fachadas criando ambientes acolhedores e amenos.

Luminária com corpo em alumínio, acabamento natural, de aspecto elegante e sóbrio.

Disponível com suporte GU10.

Wall luminaire, ideal for wall / forefront sweeping, creating warm and inviting environments.

Luminaire with aluminum body, elegant and sober appearance.

Available with GU10 lamp holder.

Luminaire de mur, idéal pour les façades créant des environnements chauds et doux.

Lampe avec corps en aluminium, finition naturelle, élégante et sobre.

Disponible avec le culot GU10.

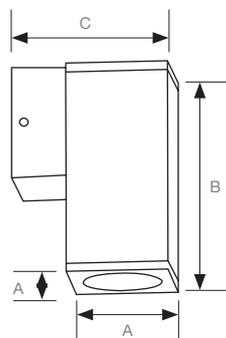

	A (mm)	B (mm)	C (mm)
Arges	63	135	97



Difusor • Difuser • Diffuseur

Vidro Temperado Transparente
Clear Tempered Glass
Verre Trempé Clair

Lâmpadas • Lamps • Lampes

Suporte - GU10
Lamp Holder - GU10
Type de Culot - GU10

Acabamento • Finishing • Finition

Alumínio Natural
Natural Aluminium
Aluminium Naturel

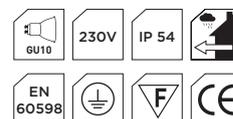

ARGES DUO

Descrição • Description • Description

Aplique de parede com emissão de luz bidirecional, ideal para varrimento de paredes/fachadas criando ambientes acolhedores e amenos.

Luminária com corpo em alumínio, acabamento natural, de aspecto elegante e sóbrio.

Disponível com suporte GU10.

Bi-directional light-emitting wall luminaire, ideal for wall / forefront sweeping, creating warm and inviting environments.

Luminaire with aluminum body, elegant and sober appearance, with simple or bidirectional light diffusion.

Available with GU10 lamp holder.

Luminaire de mur avec faisceau bidirectionnelle, idéal pour les murs de balayage / façades créant des environnements chauds et doux.

Luminaire en aluminium, finition naturelle, élégante et sobre.

Disponible avec le soutien GU10.

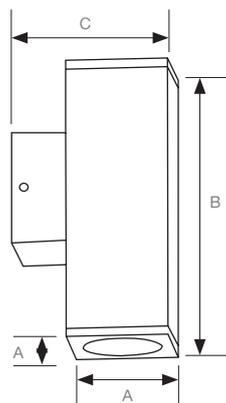

	A (mm)	B (mm)	C (mm)
Arges Duo	63	195	97



Difusor • Difuser • Diffuseur

Vidro Temperado Transparente
Clear Tempered Glass
Verre Trempé Clair

Lâmpadas • Lamps • Lampes

Suporte - 2xGU10
Lamp Holder - 2xGU10
Type de Culot - 2xGU10

Acabamento • Finishing • Finition

Alumínio Natural
Natural Aluminium
Aluminium Naturel

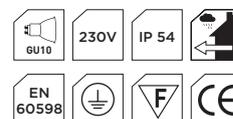



LAUS

Descrição • Description • Description

Aplique de parede de design moderno e atrativo de arestas bem delineadas e dimensões reduzidas, com um feixe de luz led ideal para sinalização e orientação. Corpo construído em alumínio, acabamento escovado com índice de protecção para utilização exterior e difusor em vidro temperado.

Modern and attractive design wall light with defined edges and small dimensions, with an led light beam ideal for signaling and orientation.

Body made of aluminum, brushed finish with protection index for exterior use and diffuser in tempered glass.

Luminaire de mur avec design moderne et attrayant avec des bords définis et de petites dimensions, avec un de faisceau de lumière idéal pour la signalisation et de l'orientation. Corps en aluminium, finition brossée avec indice de protection pour extérieur et diffuseur en verre trempé.

Difusor • Difuser • Diffuseur

Vidro Temperado Transparente
Clear Tempered Glass
Verre Trempé Clair

Lâmpadas • Lamps • Lampes

3x LED 1W - 6000K

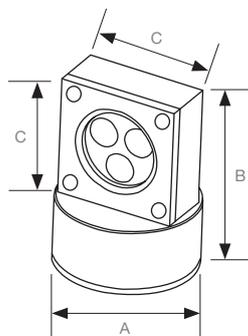

	A (mm)	B (mm)	C (mm)
Laus	80	107	69

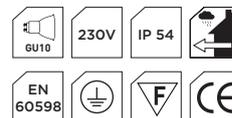

Acabamento • Finishing • Finition

Aço Escovado
Polished Steel
Acier Brossé

POLO

Descrição • Description • Description

Aplicação de parede com emissão de luz bidirecional, ideal para varrimento de paredes/fachadas criando ambientes acolhedores e amenos.

Corpo construído em alumínio, acabamento alumínio mate com índice de protecção para utilização exterior e difusor em policarbonato transparente.

Disponível com suporte GU10.

Bi-directional light-emitting wall light, ideal for wall / forefront sweeping, creating warm and inviting environments.

Body made of aluminum, matt aluminum finish with protection index for exterior use and diffuser clear polycarbonate.

Available with GU10 lamp holder.

Luminaire de mur avec émission de lumière bidirectionnelle, idéal pour les murs balayage / façades créant des environnements chauds et doux.

Corps en aluminium, finition mat en aluminium avec indice de protection pour extérieur et diffuseur en polycarbonate transparent.

Disponível com o culot GU10.

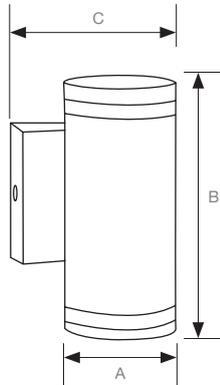

Difusor • Difuser • Diffuseur

Policarbonato Transparente
Clear Polycarbonate
Polycarbonate Transparent

Lâmpadas • Lamps • Lampes

Suporte - 2xGU10
Lamp Holder - 2xGU10
Type de Culot - 2xGU10

A (mm) B (mm) C (mm)

	A (mm)	B (mm)	C (mm)
Polo	78	220	135



Acabamento • Finishing • Finition

Alumínio Mate
Matt Aluminium
Aluminium Mat

DELOS

Descrição • Description • Description

Aplicação de parede com emissão de luz bidirecional, ideal para varrimento de paredes/fachadas criando ambientes acolhedores e amenos.

Corpo construído em alumínio, acabamento alumínio mate com índice de protecção para utilização exterior e difusor em vidro temperado.

Disponível com suporte GU10.

Bi-directional light-emitting wall luminaire, ideal for wall / forefront sweeping, creating warm and inviting environments. Body made of aluminum, matt aluminum finish with protection index for exterior use and diffuser in tempered glass.

Available with GU10 lamp holder.

Luminaire de mur avec faisceau bidirectionnelle, idéal pour les murs de balayage / façades créant des environnements chauds et doux.

Luminaire pour installation à l'extérieur en aluminium mat, finition naturelle, élégante et sobre.

Disponível com o soutien GU10.

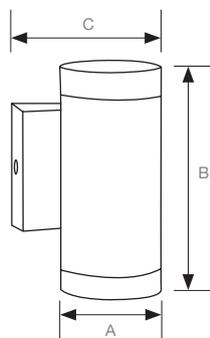

A (mm) B (mm) C (mm)

	A (mm)	B (mm)	C (mm)
Delos	65	145	112



Difusor • Difuser • Diffuseur

Vidro Temperado Transparente
Clear Tempered Glass
Verre Trempé Clair

Lâmpadas • Lamps • Lampes

Suporte - 2xGU10
Lamp Holder - 2xGU10
Type de Culot - 2xGU10

Acabamento • Finishing • Finition

Alumínio Mate
Matt Aluminium
Aluminium Mat

STAR

Descrição • Description • Description

Aplique de parede, ideal para varrimento de paredes/fachadas e como iluminação decorativa para jardins e terraços, criando ambientes acolhedores.

Corpo construído em alumínio, acabamento escovado com índice de protecção para utilização exterior e difusor em vidro transparente.

Disponível com suporte GU10.

Modern style wall light, ideal for wall / forefront sweeping and as decorative lighting for gardens and terraces, creating cozy environments.

Body made of aluminum, brushed finish with protection index for exterior use and transparent glass diffuser.

Available with GU10 lamp holder.

Luminaire de mur moderne, idéal pour balayage / façades et éclairage décoratif pour jardins et terrasses, créant des environnements accueillants.

Corps en aluminium, brossé avec indice de protection pour l'extérieur et diffuseur en verre transparent.

Disponible avec le culot GU10.

Difusor • Difuser • Diffuseur

Vidro Temperado Transparente
Clear Tempered Glass
Verre Trempé Clair

Lâmpadas • Lamps • Lampes

Suporte - GU10
Lamp Holder - GU10
Type de Culot - GU10

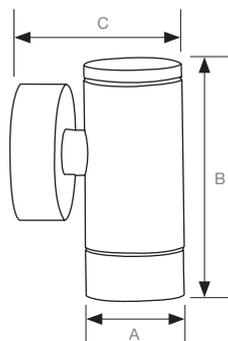

	A (mm)	B (mm)	C (mm)
Star	64,5	145	108

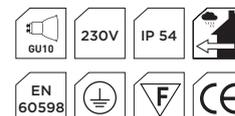

Acabamento • Finishing • Finition

Alumínio Natural
Natural Aluminium
Aluminium Naturel



STAR DUO

Descrição • Description • Description

Aplique de parede bidireccional, ideal para varrimento de paredes/fachadas e como iluminação decorativa para jardins e terraços, criando ambientes acolhedores.

Corpo construído em alumínio, acabamento escovado com índice de protecção para utilização exterior e difusor em vidro transparente.

Disponível com suporte GU10.

Modern style wall light bi-directional, ideal for wall/forefront sweeping and as decorative lighting for gardens and terraces, creating cozy environments.

Body made of aluminum, brushed finish with protection index for exterior use and transparent glass diffuser.

Available with GU10 lamp holder.

Luminaire bidirectionnelle de mur moderne avec émission de lumière simple, ou dans les deux sens, idéal pour balayage/façades et éclairage décoratif pour jardins et terrasses, créant des environnements accueillants.

Corps en aluminium, brossé avec indice de protection pour l'extérieur et diffuseur en verre transparent.

Disponible avec le culot GU10.

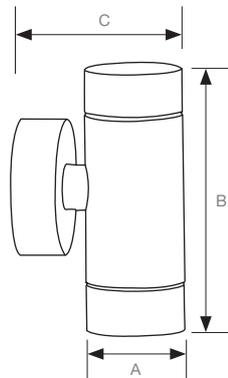

Difusor • Difuser • Diffuseur

Vidro Temperado Transparente
Clear Tempered Glass
Verre Trempé Clair

Lâmpadas • Lamps • Lampes

Suporte - 2xGU10
Lamp Holder - 2xGU10
Type de Culot - 2xGU10

A (mm) B (mm) C (mm)

Star Duo 64,5 210 108



Acabamento • Finishing • Finition

Alumínio Natural
Natural Aluminium
Aluminium Naturel



URANO

Descrição • Description • Description

Aplique de parede com emissão de luz bidirecional, ideal como sinalizador e como iluminação decorativa para jardins e terraços, criando ambientes acolhedores. Corpo construído em alumínio, várias possibilidades de acabamento, utilização exterior e difusor em vidro temperado. Produto versátil que permite a utilização de vários tipos de suportes de lâmpada.

Wall luminaire with bi-directional light emission, ideal as a signpost and as decorative lighting for gardens and terraces, creating cozy environments. Body made of aluminum, several finishing possibilities, for exterior use and diffuser in tempered glass. Versatile product that allows the use of various types of lamp holders.

Luminaire de mur avec l'émission de lumière bi-directionnel, idéal comme éclairage décoratif pour jardins et terrasses, la création d'environnements accueillants. Corps en aluminium, différentes possibilités de finition, une utilisation en extérieur et en verre trempé. produit polyvalent qui permet l'utilisation de différents types de supports de lampe.

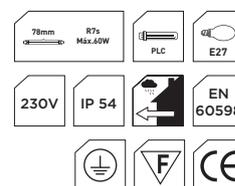

Difusor • Difuser • Diffuseur

Vidro Temperado Transparente
Clear Tempered Glass
Verre Trempé Clair

Lâmpadas • Lamps • Lampes

R7s 78 mm - máx 60W
PLC 13W/ 18W
E27

	A (mm)	B (mm)	C (mm)	D (mm)
Urano	65	164	70	170

Acabamento • Finishing • Finition

- Alumínio Mate
Matt Aluminium
Aluminium Mat
- Antracite
Urban Aluminium
Antracite
- Branco Mate
Matt White
Blanc Mat

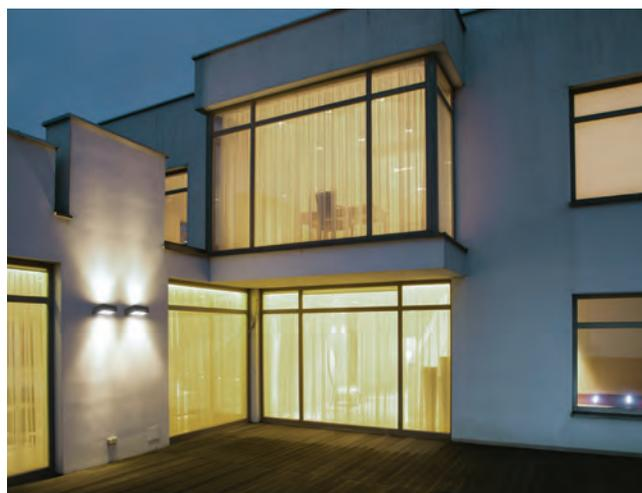
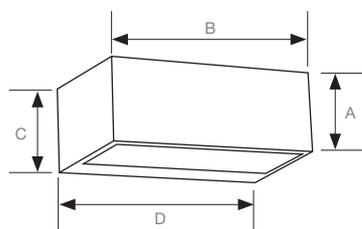

ELIPSE

Descrição • Description • Description

Elipse é uma luminária redonda ou elítica de montagem saliente. Composta por estrutura em PVC e difusor fosco é ideal para tectos maciços ou sem espaço para encastrar, apresentando um acabamento simples e ordenado. Elevado rendimento e longevidade, baixo encandeamento e iluminação homogênea ao longo da sua superfície são as suas características principais. Ideal para caixas de escadas, condomínios, áreas comuns em prédios e áreas comerciais.

Elipse is a round or elliptic shape surface mounting luminaire. Composed of PVC frame and frost diffuser is ideal for massive ceilings or without space to embed, presenting a simple and orderly finish. High performance and longevity, low glare and homogenous illumination along its surface are its main characteristics. Ideal for stair boxes, condos, common areas in buildings and commercial areas.

Elipse est un luminaire à montage en plafonnier de forme ronde ou elliptique. Composé d'un châssis en PVC et d'un diffuseur grivé, il est idéal pour plafonnier ou espaces restreints, offrant une finition simple et uniforme. Ses principales caractéristiques sont une haute performance et une longévité, un faible éblouissement et un éclairage homogène le long de sa surface. Idéal pour les escaliers, les condos, les zones communes dans les bâtiments et les zones commerciales.

Difusor • Difuser • Diffuseur

PVC Fosco
Frosted PVC
PVC Opaline

Lâmpadas • Lamps • Lampes

LED 12W - 4000K

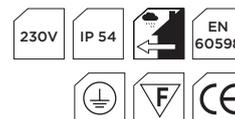

Redondo • Round • Rond

Elipse R	A (mm)	B (mm)	C (mm)	Lumens
12 W	193	193	75	1080 lm

Elíptico • Elliptic • Elliptique

Elipse E	A (mm)	B (mm)	C (mm)	Lumens
12 W	210	117	65	1080 lm

Acabamento • Finishing • Finition

■ Preto
Black
Noir

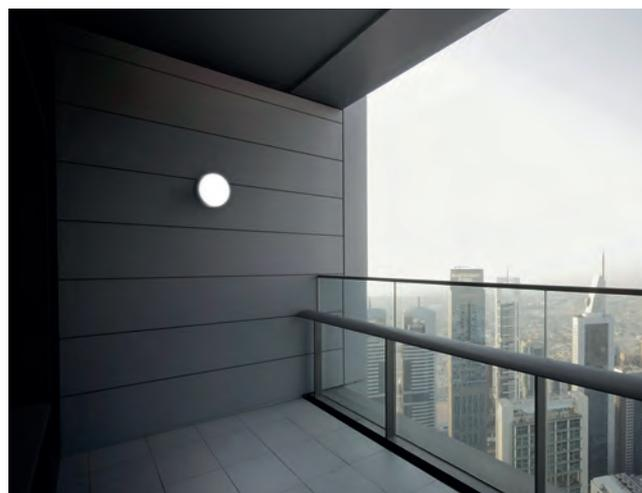
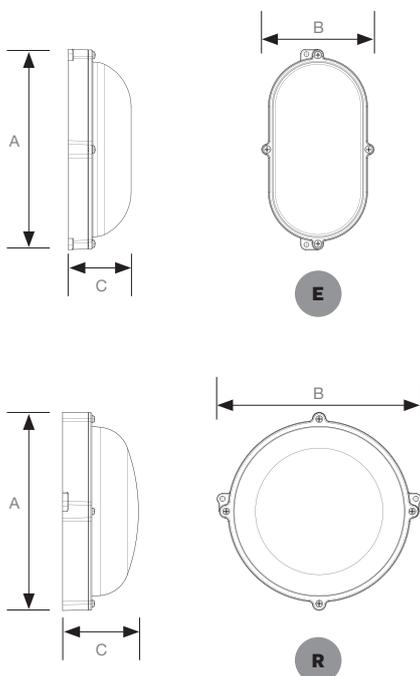

APOLO ICE Q

Descrição • Description • Description

Luminária de parede quadrada, de pequenas dimensões, ideal para delimitar zonas de passagem, escadas, caminhos de jardim, áreas exteriores dos edifícios e áreas interiores como hotéis, teatros, salas de concertos e cinemas.

Corpo em alumínio, aro em aço inox e difusor em vidro fosco.

Caixa de encastrar em PVC e driver fornecidos de série.

Small square wall luminaire, ideal for delimiting passageways, stairs, garden paths, exterior areas of buildings and interior areas such as hotels, theaters, concert halls and cinemas.

Aluminum body, stainless steel frame and frosted glass diffuser.

Recessed PVC housing and driver supplied as standard.

Luminaire mural carré, idéal pour délimiter les passages, les escaliers, les chemins de jardin, les espaces extérieurs des bâtiments et les espaces intérieurs comme hôtels, les théâtres, les salles de concert et les cinémas.

Corps en aluminium, cadre en acier inoxydable et diffuseur en verre opaline.

Boîte en PVC encastré et driver fournis en standard.



Difusor • Diffuser • Diffuseur

Vidro Fosco
Frosted Glass
Verre Trempé Opaline

Lâmpadas • Lamps • Lampes

LED 3W - 6000K

1	Apolo Ice Q	A (mm)	Lumens	
		105	270 lm	
2	Caixa de Encastrar em PVC PVC Recessed Box Boîte d'encastrement en PVC	B (mm)	C (mm)	D (mm)
		96	72	55

Acabamento • Finishing • Finition

Aço Inox 304
Stainless Steel 304
Acier Inoxydable 304

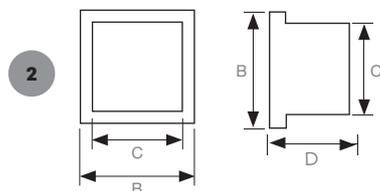

APOLO Q

Descrição • Description • Description

Luminária de parede quadrada, de pequenas dimensões, ideal para delimitar zonas de passagem, escadas, caminhos de jardim, áreas exteriores dos edifícios e áreas interiores como hotéis, teatros, salas de concertos e cinemas.
 Corpo em alumínio, aro em aço inox com grelha e difusor em vidro fosco.
 Caixa de encastrar em PVC e driver fornecidos de série.

*Small square wall luminaire, ideal for delimiting passageways, stairs, garden paths, exterior areas of buildings and interior areas such as hotels, theaters, concert halls and cinemas.
 Aluminum body, stainless steel frame with grille and frosted glass diffuser.
 Recessed PVC housing and driver supplied as standard.*

*Luminaire mural carré, idéal pour délimiter les passages, les escaliers, les chemins de jardin, les espaces extérieurs des bâtiments et les espaces intérieurs comme hôtels, les théâtres, les salles de concert et les cinémas.
 Corps en aluminium, cadre en acier inoxydable avec calandre et diffuseur en verre opaline.
 Boîte en PVC encastré et driver fournis en standard.*



Difusor • Diffuser • Diffuseur

Vidro Fosco
 Frosted Glass
 Verre Trempé Opaline

1	ApoLO Q	A (mm)	Lumens		
		105	270 lm		
	Caixa de Encastrar em PVC PVC Recessed Box Boîte d'encastrement en PVC	B (mm)	C (mm)	D (mm)	
		96	72	55	

Acabamento • Finishing • Finition

Aço Inox 304
 Stainless Steel 304
 Acier Inoxydable 304

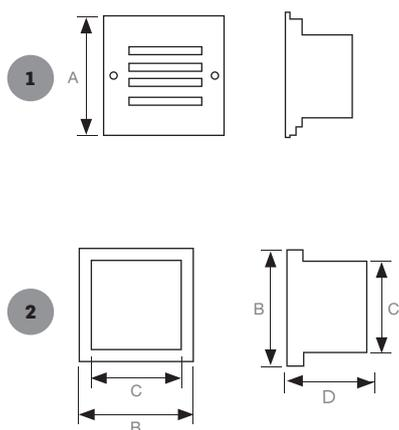

APOLO ICE

Descrição • Description • Description

Luminária de parede rectangular, de pequenas dimensões, ideal para delimitar zonas de passagem, escadas, caminhos de jardim, áreas exteriores dos edifícios e áreas interiores como hotéis, teatros, salas de concertos e cinemas.
 Corpo em alumínio, aro em aço inox e difusor em vidro fosco.
 Caixa de encastrar em PVC e driver fornecidos de série.

*Small rectangular wall luminaire, ideal for delimiting passageways, stairs, garden paths, exterior areas of buildings and interior areas such as hotels, theaters, concert halls and cinemas.
 Aluminum body, stainless steel frame and frosted glass diffuser.
 Recessed PVC housing and driver supplied as standard.*

*Luminaire mural rectangulaire, idéal pour délimiter les passages, les escaliers, les chemins de jardin, les espaces extérieurs des bâtiments et les espaces intérieurs comme hôtels, les théâtres, les salles de concert et les cinémas.
 Corps en aluminium, cadre en acier inoxydable et diffuseur en verre opaline.
 Boîte en PVC encastré et pilote fournis en standard.*



Difusor • Diffuser • Diffuseur

Vidro Fosco
 Frosted Glass
 Verre Trempé Opaline

Lâmpadas • Lamps • Lampes

LED 3W - 6000K

1	ApoIo Ice	A (mm)	B (mm)	Lumens
		169	70	270 lm

2	Caixa de Encastrar em PVC PVC Recessed Box Boîte d'encastrer en PVC	C (mm)	D (mm)	E (mm)	F (mm)	G (mm)
		155	127	55	46	55

Acabamento • Finishing • Finition

Aço Inox 304
 Stainless Steel 304
 Acier Inoxydable 304

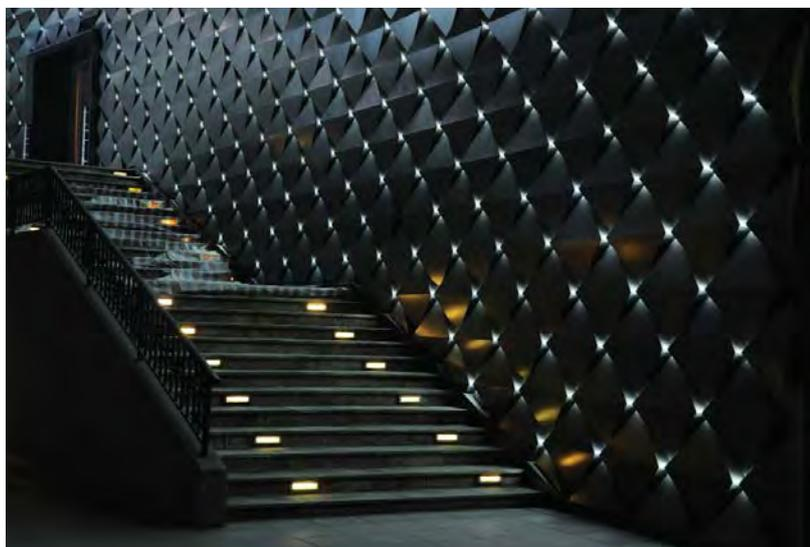
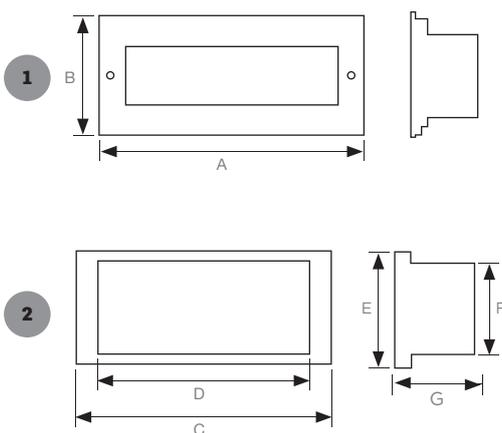

APOLO

Descrição • Description • Description

Luminária de parede rectangular, de pequenas dimensões, ideal para delimitar zonas de passagem, escadas, caminhos de jardim, áreas exteriores dos edifícios e áreas interiores como hotéis, teatros, salas de concertos e cinemas.
Corpo em alumínio, aro em aço inox com grelha e difusor em vidro fosco.
Caixa de encastrar em PVC e driver fornecidos de série.

Small rectangular wall luminaire, ideal for delimiting passageways, stairs, garden paths, exterior areas of buildings and interior areas such as hotels, theaters, concert halls and cinemas.

*Aluminum body, stainless steel frame with grille and frosted glass diffuser.
Recessed PVC housing and driver supplied as standard.*

*Luminaire mural rectangulaire, idéal pour délimiter les passages, les escaliers, les chemins de jardin, les espaces extérieurs des bâtiments et les espaces intérieurs comme hôtels, les théâtres, les salles de concert et les cinémas.
Corps en aluminium, cadre en acier inoxydable avec calandre et diffuseur en verre opaline.
Boîte en PVC encastré et pilote fournis en standard.*



Difusor • Diffuser • Diffuseur

Vidro Fosco
Frosted Glass
Verre Trempé Opaline

Lâmpadas • Lamps • Lampes

LED 3W - 6000K

1	Apo	A (mm)	B (mm)	Lumens
		169	70	270 lm

2	Caixa de Encastrar em PVC PVC Recessed Box Boîte d'encastrer en PVC	C (mm)	D (mm)	E (mm)	F (mm)	G (mm)
		155	127	55	46	55

Acabamento • Finishing • Finition

Aço Inox 304
Stainless Steel 304
Acier Inoxydable 304

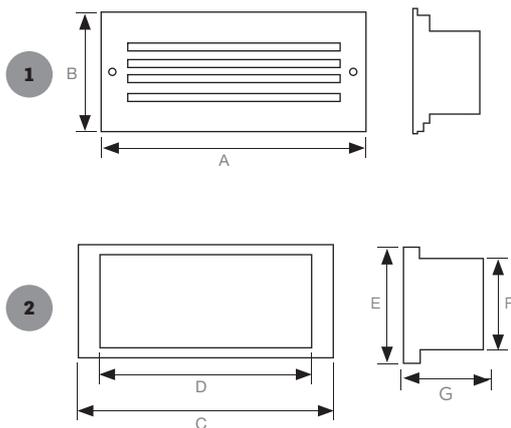

Exterior Chão

Exterior Ground

Extérieur Sol

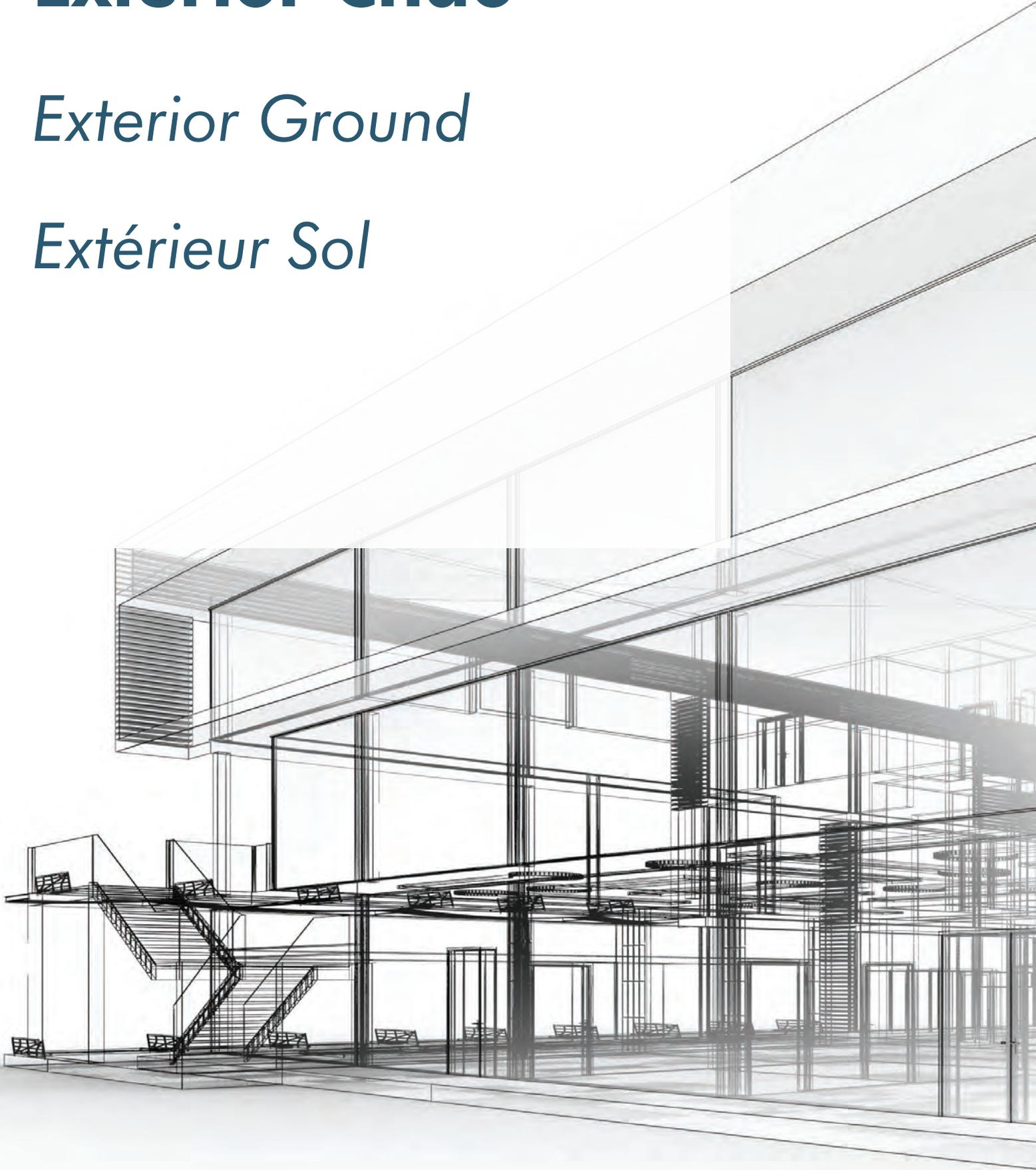

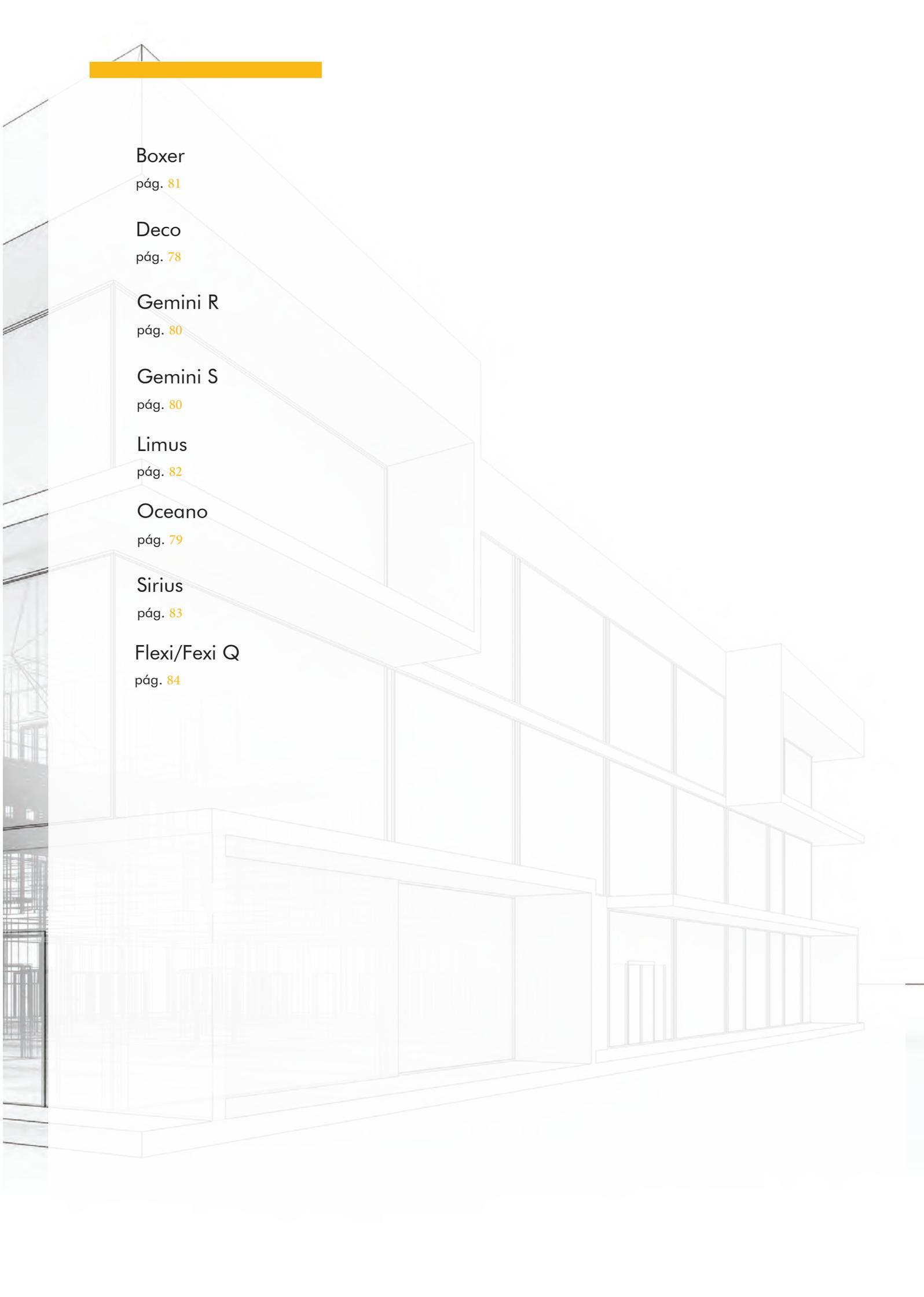

Boxer

πάγ. 81

Deco

πάγ. 78

Gemini R

πάγ. 80

Gemini S

πάγ. 80

Limus

πάγ. 82

Oceano

πάγ. 79

Sirius

πάγ. 83

Flexi/Fexi Q

πάγ. 84

DECO

Descrição • Description • Description

Luminária de chão redonda com possibilidade de orientação da lâmpada cerca de 30°, ideal para varrimento de paredes/fachadas, jardins e passadiços criando ambientes acolhedores e amenos.

Aro redondo em aço inox 314 com tratamento anti corrosão, de montagem encastrada, com índice de protecção para utilização exterior e difusor em vidro temperado.

Produto versátil que permite a utilização de vários tipos de suportes de lâmpada. Caixa de encastrar em PVC disponível.

Round floor luminaire with possibility of orientation of the lamp in about 30°, ideal for scanning walls / forefronts, gardens and walkways creating cozy and pleasant environments.

314 stainless steel round ring with anti-corrosion treatment, recessed mounting, with protection index for outdoor use and tempered glass diffuser.

Versatile product that allows the use of various types of lamp holders. PVC recessed box available.

Luminaire sol extérieur ronde avec possibilité d'orientation de la lampe à environ 30°, idéal pour balayer murs, façades, jardins et allées créant des environnements agréables et chaleureux.

Avec cadre ronde en acier inoxydable 314 avec traitement anti-corrosion, montage encastré, indice de protection pour utilisation à l'extérieur et diffuseur en verre trempé.

Produit polyvalent qui permet l'utilisation de divers types de culot. Boîte encastrée en PVC disponible.

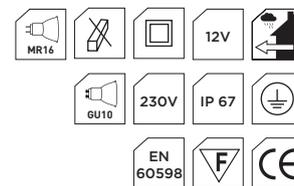

Difusor • Diffuser • Diffuseur

Vidro Temperado Transparente, IK9
Clear Tempered Glass, IK9
Verre Trempé Clair, IK9

Lâmpadas • Lamps • Lampes

GU 10 Max. 50W / MR16 Max. 50W

1 Deco	A (mm)	B (mm)	C (mm)
	72	87	110

2	A (mm)	B (mm)	C (mm)	D (mm)
Caixa de Encastrar em PVC PVC Recessed Box Boîte d'encastrer en PVC	75	114	102	123

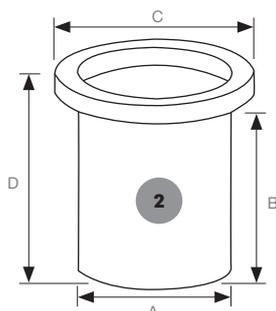
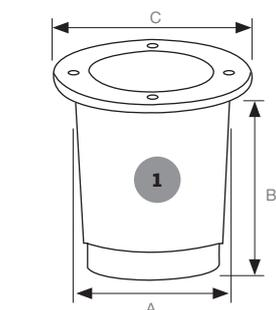

Acabamento • Finishing • Finition

Aço Inox 314
Stainless Steel 314
Acier Inoxydable 314



OCEANO

Descrição • Description • Description

Luminária de chão quadrada com possibilidade de orientação da lâmpada cerca de 30°, ideal para varrimento de paredes/fachadas, jardins e passadiços criando ambientes acolhedores e amenos. Aro redondo em aço inox 314 com tratamento anti corrosão, de montagem encastrada, com índice de protecção para utilização exterior e difusor em vidro temperado. Produto versátil que permite a utilização de vários tipos de suportes de lâmpada. Caixa de encastrar em PVC disponível.

Square floor luminaire with possibility of orientation of the lamp in about 30°, ideal for scanning walls / forefronts, gardens and walkways creating cozy and pleasant environments.

314 stainless steel round ring with anti-corrosion treatment, recessed mounting, with protection index for outdoor use and tempered glass diffuser.

Versatile product that allows the use of various types of lamp holders. PVC recessed box available.

Luminaire sol extérieur carré avec possibilité d'orientation de la lampe à environ 30°, idéal pour balayer murs, façades, jardins et allées créant des environnements agréables et chaleureux.

Avec cadre ronde en acier inoxydable 314 avec traitement anti-corrosion, montage encastré, indice de protection pour utilisation à l'extérieur et diffuseur en verre trempé.

Produit polyvalent qui permet l'utilisation de divers types de culot. Boîte encastrée en PVC disponible.

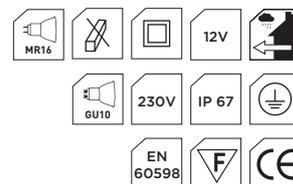

Difusor • Diffuser • Diffuseur

Vidro Temperado Transparente, IK9
Clear Tempered Glass, IK9
Verre Trempé Clair, IK9

Lâmpadas • Lamps • Lampes

GU 10 Max. 50W / MR16 Max. 50W

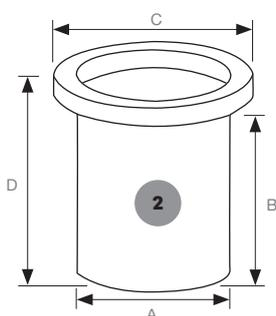
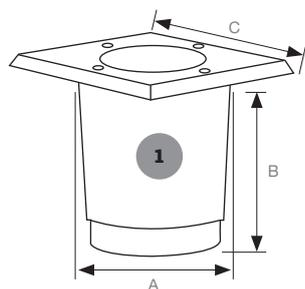

	A (mm)	B (mm)	C (mm)	D (mm)
1 Oceano	72	87	110	
2 Caixa de Encastrar em PVC PVC Recessed Box Boîte d'encastrer en PVC	75	114	102	123

Acabamento • Finishing • Finition

Aço Inox 314
Stainless Steel 314
Acier Inoxydable 314



GEMINI R

Descrição • Description • Description

Luminária de pavimento/parede redonda, ideal para delimitar caminhos de jardim ou áreas exteriores dos edifícios.

Corpo em aço inox com elevado índice de protecção.

Caixa de encastrar em PVC, cabo de 1,5m e driver fornecidos de série.

Round floor/wall luminaire, ideal for delimiting garden paths or exterior buildings areas. Stainless steel body with high protection. PVC recessed box, 1.5m cable and driver supplied as standard.

Luminaire de sol/mur, idéale pour extérieurs et idéal pour délimiter les passages. Corps en aluminium avec indice de protection élevé.

Boîte encastrée en PVC, câble de 1,5m et driver fournis.

Lâmpadas • Lamps • Lampes

LED 1W - 3000K

Acabamento • Finishing • Finition

Aço inox 304
Stainless Steel 304
Acier Inoxydable 304

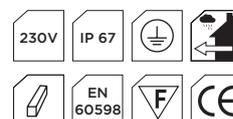
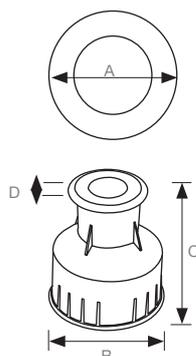

A (mm)	B (mm)	C (mm)	D (mm)	Lumens
52	80	87	4	90 lm

GEMINI S

Descrição • Description • Description

Luminária de pavimento/parede quadrada, ideal para delimitar caminhos de jardim ou áreas exteriores dos edifícios.

Corpo em aço inox com elevado índice de protecção.

Caixa de encastrar em PVC, cabo de 1,5m e driver fornecidos de série.

Square floor/wall luminaire, ideal for delimiting garden paths or exterior areas of buildings. Stainless steel body with high protection. PVC recessed box, 1.5m cable and driver supplied as standard.

Luminaire de sol/mur, idéale pour extérieurs et idéal pour délimiter les passages. Corps en acier inoxydable avec indice de protection élevé.

Boîte encastrée en PVC, câble de 1,5m et driver fournis.

Lâmpadas • Lamps • Lampes

LED 1W - 3000K

Acabamento • Finishing • Finition

Aço Inox
Stainless Steel
Acier Inoxydable

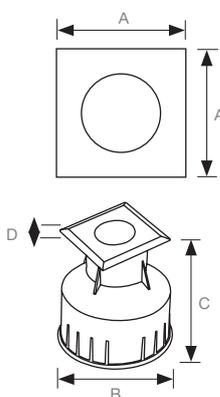

A (mm)	B (mm)	C (mm)	D (mm)	Lumens
52	80	87	4	90 lm

BOXER

Descrição • Description • Description

Luminária de pavimento redonda, ideal para delimitar áreas exteriores dos edifícios. Corpo em alumínio injectado, com tratamento anti corrosão, aro em aço inox 304, reflector em alumínio de elevada pureza, fornecida com duplo vidro temperado de elevado índice de protecção para que a temperatura à superfície de vidro exterior seja mais baixa. Caixa de encastrar em PVC não incluída.

Round floor fixture, ideal for delimiting exterior buildings areas. Injected aluminum body with anti-corrosion treatment, 304 stainless steel rim, high purity aluminum reflector, supplied with double tempered glass with a high index of protection, so that the temperature on the exterior glass surface is lower. PVC recessed box not included.

Applique de sol rond, idéale pour délimiter les espaces extérieurs du bâtiment. Corps en aluminium injecté avec traitement anticorrosion, cadre en acier inoxydable 304, réflecteur en aluminium de haute pureté avec diffuseur transparent double verre à haut indice de protection. Produit polyvalent qui permet l'utilisation de divers types de culot. Boîte encastrée en PVC non inclus.

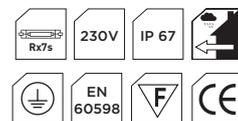

Difusor • Diffuser • Diffuseur

Vidro Temperado Transparente, IK10
 Clear Tempered Glass, IK10
 Verre Trempé Clair, IK10

Lâmpadas • Lamps • Lampes

Iod. Met./ Metal halide Rx7s - 70W
 Iod. Met./ Metal halide Rx7s - 150W
 SAP/HPS - 70W

Boxer

A (mm) B (mm)

280 420

Acabamento • Finishing • Finition

Aço Inox 304
 Stainless Steel 304
 Acier Inoxydable 304

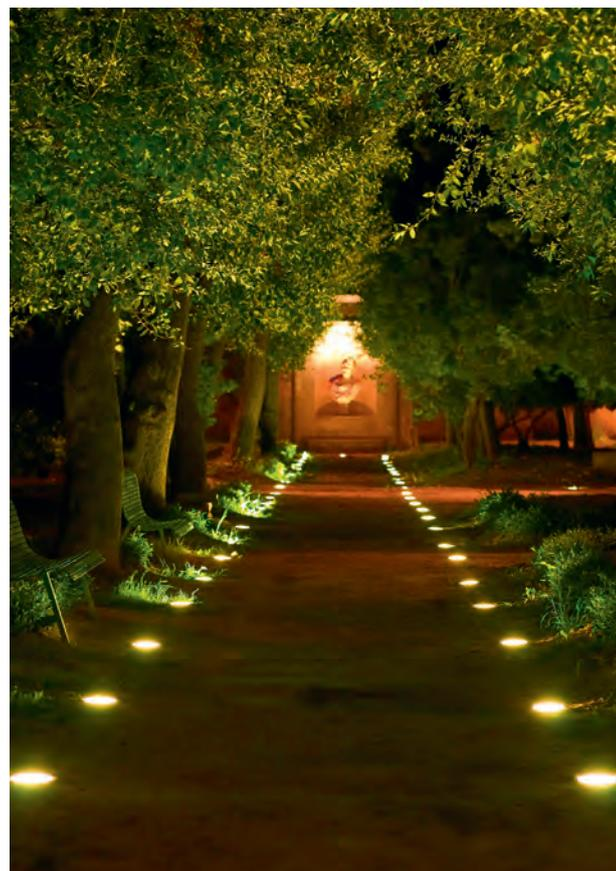
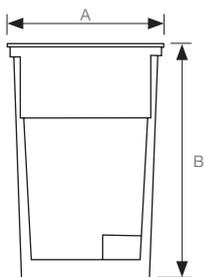

LIMUS

Descrição • Description • Description

Luminária de pavimento quadrada, ideal para delimitar áreas exteriores dos edifícios. Corpo em alumínio injectado, com tratamento anti corrosão, aro em aço inox 316, reflector em alumínio de elevada pureza com difusor em vidro temperado transparente de elevado índice de protecção.

Produto versátil que permite a utilização de vários tipos de suportes de lâmpada. Caixa de encastrar em PVC não incluída.

Square floor fixture, ideal for delimiting building's exterior areas. Injected aluminum body with anti-corrosion treatment, 316 stainless steel rim, high purity aluminum reflector with transparent high-gloss diffuser with high protection index. Versatile product that allows the use of various types of lamp holders.

PVC recessed box not included.

Applique de sol carré, idéale pour délimiter les espaces extérieurs du bâtiment. Corps en aluminium injecté avec traitement anticorrosion, cadre en acier inoxydable 316, réflecteur en aluminium de haute pureté avec diffuseur transparent à haut indice de protection.

Produit polyvalent qui permet l'utilisation de divers types de culot.

Boîte encastrée en PVC non inclus.

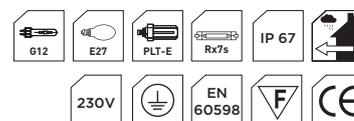

Limus

A (mm) B (mm)

260

327

Difusor • Diffuser • Diffuseur

Vidro Temperado Transparente, IK10
Clear Tempered Glass, IK10
Verre Trempé Clair, IK10

Acabamento • Finishing • Finition

Aço Inox 316
Stainless Steel 316
Acier Inoxydable 316

Lâmpadas • Lamps • Lampes

Iod. Met./ Metal halide Rx7s - 70W
Iod. Met./ Metal halide Rx7s - 150W
SAP/HPS - 70W
G12 - 70W
G12 - 150W
Comp. fluo. (PLT-E) - Max. 32W
E27

Opcional • Optional • Optional



Caixa de derivação plástica para projector de pavimento com 1 entrada/2 saídas

Plastic shunt box for 1-way / 2-way flooring projector

Boîte de dérivation en plastique pour projecteur de sol 1 entrée / 2 sorties



Caixa de derivação em aço inox para projector de pavimento com 1 entrada/5 saídas

Stainless steel junction box for floor light with 1 input / 5 outputs

Boîte de jonction en acier inoxydable pour projecteur de sol avec 1 entrée / 5 sorties

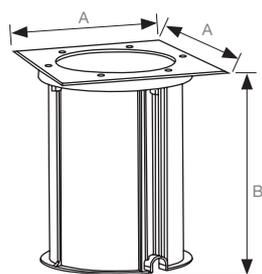

SIRIUS

Descrição • Description • Description

Luminária de pavimento redonda, ideal para delimitar áreas exteriores dos edifícios. Corpo em alumínio injectado, com tratamento anti corrosão, aro em aço inox 316, reflector em alumínio de elevada pureza com difusor em vidro temperado transparente de elevado índice de protecção. Produto versátil que permite a utilização de vários tipos de suportes de lâmpada. Caixa de encastrar em PVC não incluída.

Round floor fixture, ideal for delimiting building's exterior areas. Injected aluminum body with anti-corrosion treatment, 316 stainless steel rim, high purity aluminum reflector with transparent high-gloss diffuser with high protection index. Versatile product that allows the use of various types of lamp holders. PVC recessed box not included.

Applique de sol rond, idéale pour délimiter les espaces extérieurs du bâtiment. Corps en aluminium injecté avec traitement anticorrosion, cadre en acier inoxydable 316, réflecteur en aluminium de haute pureté avec diffuseur transparent à haut indice de protection.

Produit polyvalent qui permet l'utilisation de divers types de culot. Boîte encastrée en PVC non inclus.

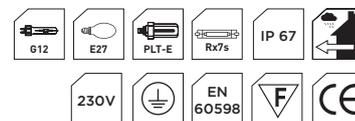

Sirius

A (mm)	B (mm)
260	327

Difusor • Diffuser • Diffuseur

Vidro Temperado Transparente, IK10
 Clear Tempered Glass, IK10
 Verre Trempé Clair, IK10

Lâmpadas • Lamps • Lampes

Iod. Met./ Metal halide Rx7s - 70W
 Iod. Met./ Metal halide Rx7s - 150W
 SAP/HPS - 70W
 G12 - 70W
 G12 - 150W
 Comp. fluo. (PLT-E) - Max. 32W
 E27

Acabamento • Finishing • Finition

Aço Inox 316
 Stainless Steel 316
 Acier Inoxydable 316

Opcional • Optional • Optional



Caixa de derivação plástica para projector de pavimento com 1 entrada/2 saídas

Plastic shunt box for 1-way / 2-way flooring projector

Boîte de dérivation en plastique pour projecteur de sol 1 entrée / 2 sorties



Caixa de derivação em aço inox para projector de pavimento com 1 entrada/5 saídas

Stainless steel junction box for floor light with 1 input / 5 outputs

Boîte de jonction en acier inoxydable pour projecteur de sol avec 1 entrée / 5 sorties

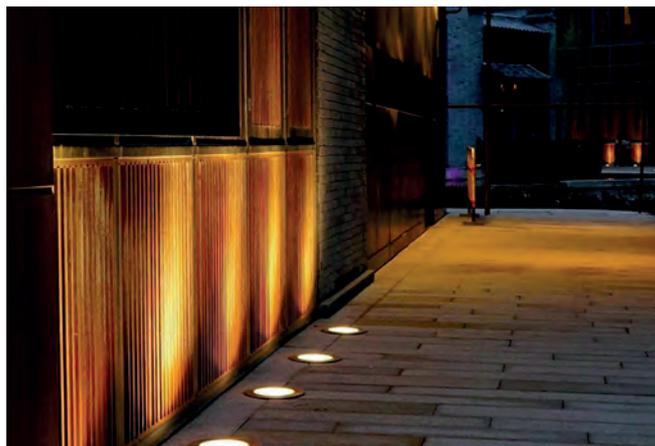
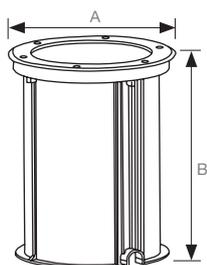

FLEXI / FLEXI Q

Descrição • Description • Description

Luminária de pavimento/parede redonda ou quadrada, de pequenas dimensões, ideal para delimitar caminhos de jardim ou áreas exteriores dos edifícios.

Corpo em alumínio repuxado com elevado índice de protecção e lente de projecção de 90°.

Caixa de encastrar em PVC e cabo de 1,5m fornecidos de série.

LED driver e cabo com 4,5m para ligação até 6 luminárias não incluídos.

LED driver de 3W para ligações de 1 a 3 unidades

LED driver de 6W para ligações de 3 a 6 unidades

Ligação em serie.

Small round or square floor/wall luminaire, ideal for delimiting garden paths or exterior areas of buildings. High-protection aluminum body with 90° projection lens.

Recessed PVC box and 1,5m cable supplied as standard.

LED driver and cable with 4,5m for connection to 6 optional luminaires not included.

1-3W LED driver for connections from 1 to 3 units

3-6W LED driver for connections from 3 to 6 units

Serial connection.

Luminaire de sol/mur rond ou carré, idéale pour extérieurs et idéal pour délimiter les passages.

Corps en aluminium avec indice de protection élevé et lentille de 90°.

Boîte encastrée en PVC, câble de 1,5m et driver fournis.

1-3W LED driver pour 1 a 3 leds.

3-6W LED driver de 3 a 6 leds.

Connexions en série.

Lâmpadas • Lamps • Lampes

LED 1W - 3000K

Acabamento • Finishing • Finition

Alumínio

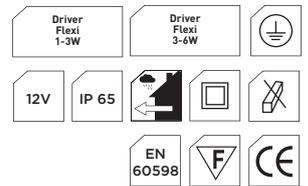
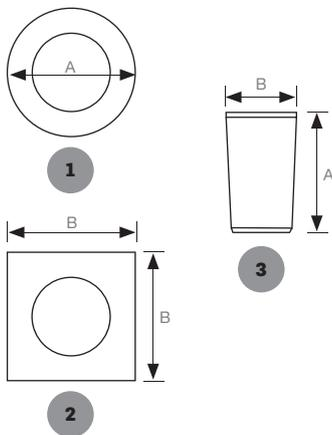

	A (mm)	Lumens
1 Flexi R	42	80
2 Flexi Q		
	B (mm)	
2 Flexi Q	45	80
3 Caixa de Encastrar em PVC PVC Recessed Box Boîte encastrée en PVC		
	A (mm)	B (mm)
3	60	37

Ligações • Connections • Connexions

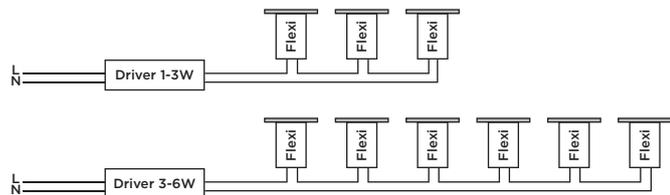



Iluminação Pública

*Street
Lighting*

*Luminaire
Public*

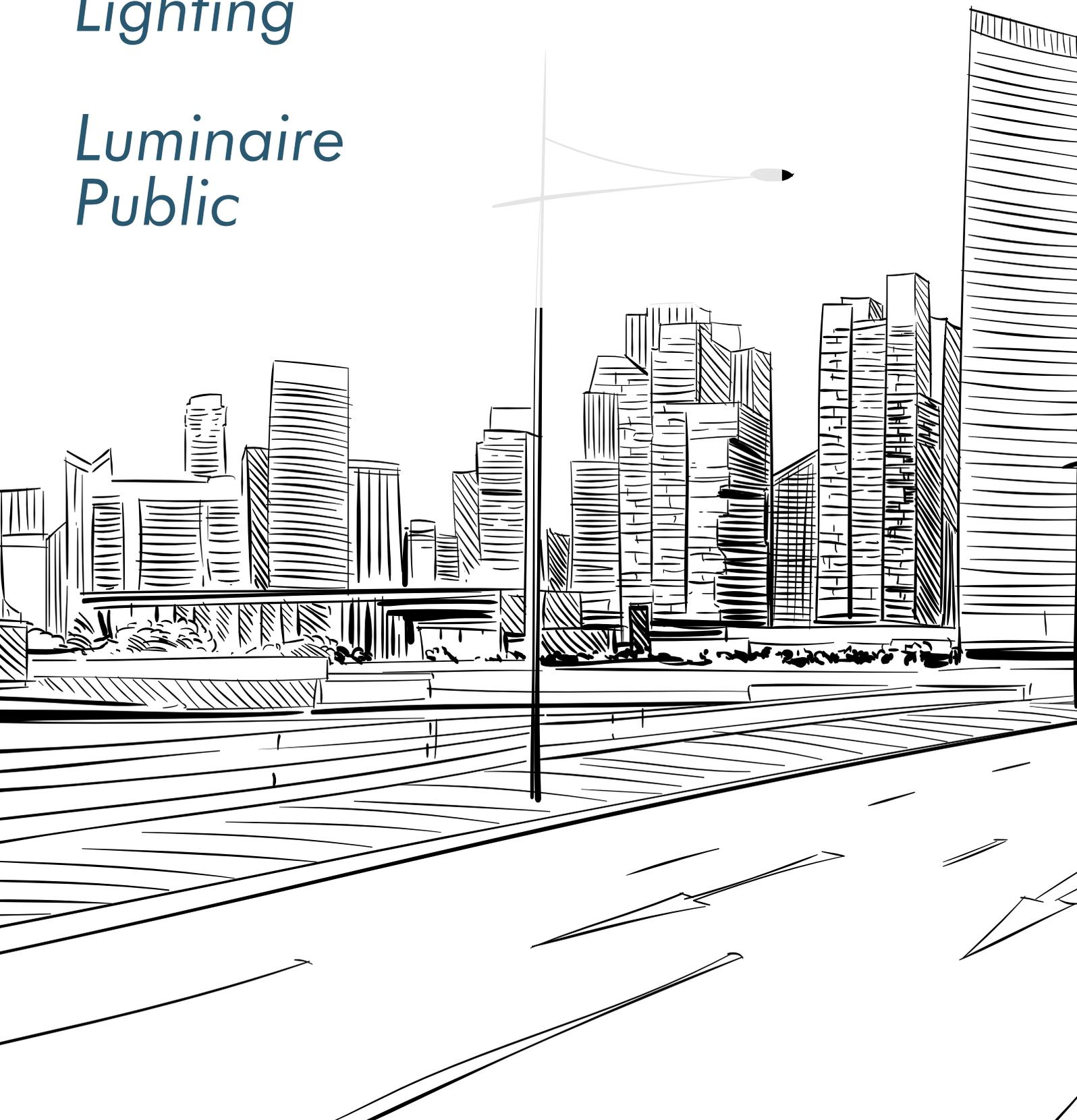

Argos

πάγ. 88

Nisa

πάγ. 89

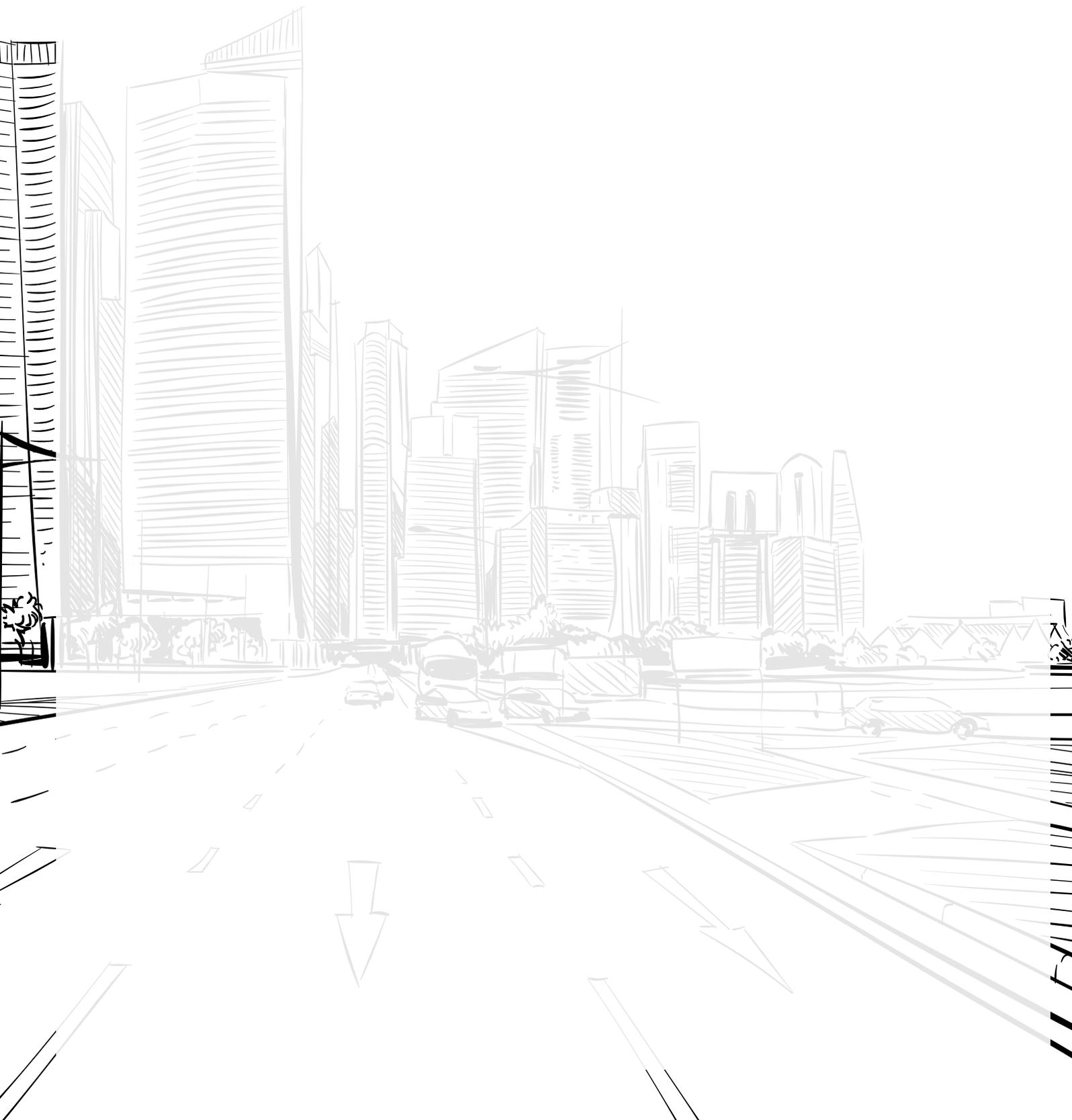

ARGOS

Descrição • Description • Description

Armadura de design simples e elegante, com uma excelente eficiência luminosa para iluminação viária.
Desenvolvida em alumínio fundido com tratamento anticorrosivo para uma elevada resistência às condições atmosféricas.

*Simple and elegant luminaire with excellent light efficiency for street lighting.
Developed in cast aluminum with anticorrosive treatment for a high resistance to atmospheric conditions.*

*Luminaire simple et élégante avec un excellent rendement lumineux pour l'éclairage routier.
Développé en aluminium forgé avec un traitement anti-corrosion et de grande résistance aux conditions atmosphériques.*

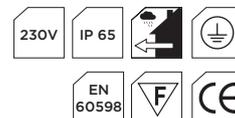
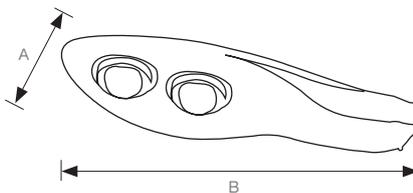

Lâmpadas • Lamps • Lampes

LED 50W, 100W, 150W

Acabamento • Finishing • Finition

Cinza
Grey
Gris

Argos	A (mm)	B (mm)	Lumens
50 W	250	460	4500 lm
100 W	250	660	9000 lm
150 W	250	860	13500 lm





NISA

Descrição • Description • Description

A armadura Nisa, é um equipamento compacto e económico, com elevada eficiência luminosa para iluminação viária. Disponível em potências 30W, 50W e 100W.

The Nisa, is a compact and economical fixture with high luminous efficiency for street lighting. Available in powers 30W, 50W and 100W.

Le Nisa, est un appareil éclairage routier compact et économique avec un rendement lumineux élevée pour. Disponible en puissances de 30W, 50W et 100W.

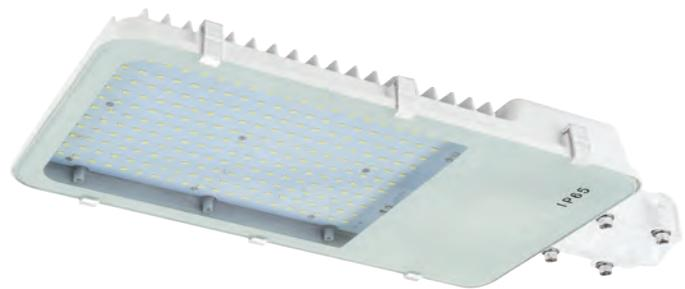

Difusor • Diffuser • Diffuseur

Vidro Temperado Transparente
Clear Tempered Glass
Verre Trempé Clair

Lâmpadas • Lamps • Lampes

LED 30W, 50W, 100W - 6000K

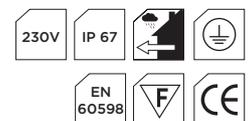
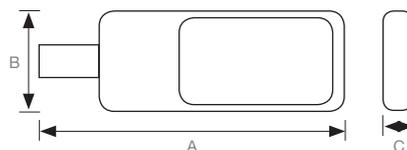

Acabamento • Finishing • Finition

Branco Mate
Matt White
Blanc Mat

Nisa	A mm	B mm	C mm	Lumens
30 W	400	135	65	2700 lm
50 W	500	210	70	4500 lm
100 W	555	250	80	9000 lm



Exterior Projectores

*Exterior
Flood light*

*Projecteur
Extérieur*

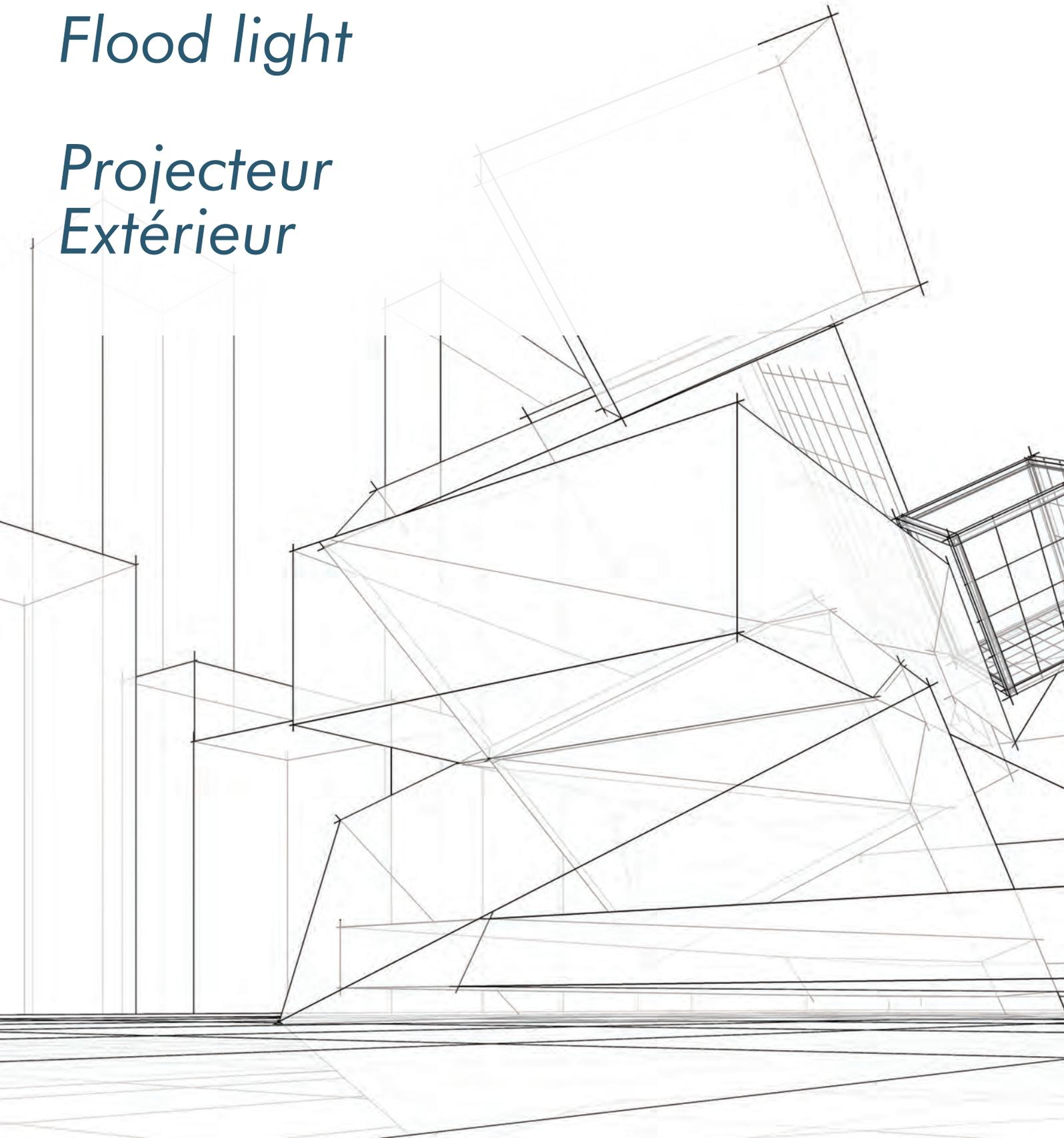



Douro

πάγ. 94

Mondego

πάγ. 93

Orion

πάγ. 95

Sado

πάγ. 92

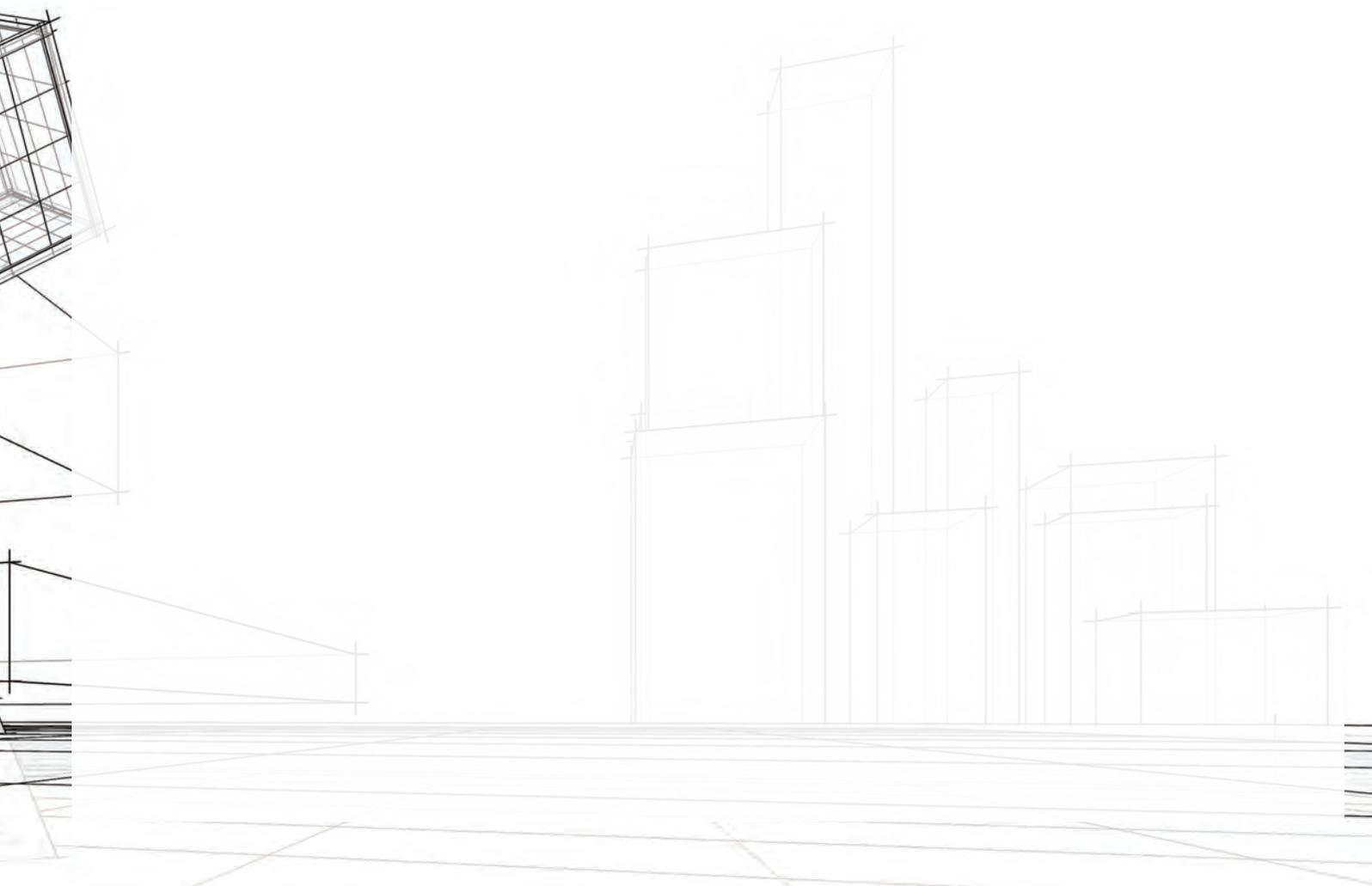

SADO

Descrição • Description • Description

O projector Sado, é um equipamento compacto e económico, concebido para instalações exteriores.

Os níveis de luz obtidos, permitem uma ampla gama de aplicações quer na área de segurança com circuitos de CCTV, quer na área decorativa com o varrimento de paredes e fachadas de monumentos quer também para áreas desportivas e equipamentos municipais.

Disponível em potências 50W, 100W e 150W.

The Sado projector is compact and economical, designed for outdoor installations.

The light levels obtained allow a wide range of applications, both in the security area with CCTV circuits and in the decorative area with the scanning of walls and facades of monuments as well as sports areas and municipal equipment.

Available in powers 50W, 100W and 150W.

Le projecteur Sado est compact et économique, conçu pour les installations extérieures.

Les niveaux d'éclairage obtenus permettent un large éventail d'applications, tant du côté sécurité avec circuits de vidéosurveillance comme dans le décorative avec le balayage des murs et des façades de monuments ainsi que des zones sportives et équipements municipaux.

Disponible dans les puissances 50W, 100W et 150W.

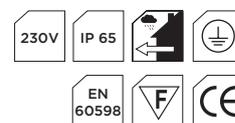

Sado	A (mm)	B (mm)	C (mm)	Lumens
50 W	210	105	50	4750 lm
100 W	260	250	50	9500 lm
150 W	330	210	50	14250 lm

Difusor • Diffuser • Diffuseur

PMMA

Acabamento • Finishing • Finition

Cinza
Grey
Gris

Lâmpadas • Lamps • Lampes

LED 6000K

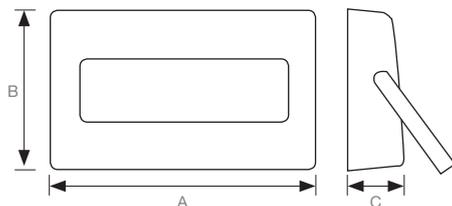

MONDEGO

Descrição • Description • Description

Nova gama de projectores de design apurado maximizando a eficácia luminosa. Com tecnologia multiled, através da qual conseguimos obter uma projecção luminosa mais homogénea.

Os níveis de luz obtidos, permitem uma ampla gama de aplicações de iluminação quer na área de segurança com circuitos de CCTV, quer na área decorativa com o varrimento de paredes e fachadas de monumentos.

Disponível em potências entre 10W e 200W.

New range of design projectors designed to maximize luminous efficiency. With multiled technology, through which we achieve a more homogenous light projection. The light levels obtained allow a wide range of lighting applications, both in the security area with CCTV circuits and in the decorative area with the scanning of walls and facades of monuments. Available in powers between 10W and 200W.

Nouvelle gamme de projecteurs, design conçu pour maximiser l'efficacité lumineuse. Avec la technologie multiled, grâce à laquelle nous réalisons une projection de lumière plus homogène.

Les niveaux lumineux obtenus permettent une large gamme d'applications d'éclairage, tant au niveau de sécurité avec circuits de vidéo-surveillance comme dans la zone décorative avec le balayage des murs et des façades des monuments.

Disponível em potência entre 10W e 200W.

Difusor • Diffuser • Diffuseur

Vidro Temperado Transparente
 Clear Tempered Glass
 Verre Trempé Clair

Lâmpadas • Lamps • Lampes

LED SMD 3000K, 6000K



Mondego	A (mm)	B (mm)	C (mm)	Lumens
10 W	120	110	40	950 lm
20 W	160	140	50	1900 lm
30 W	180	155	50	2850 lm
50 W	230	190	50	4750 lm
100 W	310	270	50	9500 lm
200 W	480	275	50	19000 lm

Mondego	3000K	6000K
10 W	•	•
20 W	•	•
30 W	•	•
50 W	•	•
100 W	•	•
200 W	•	•

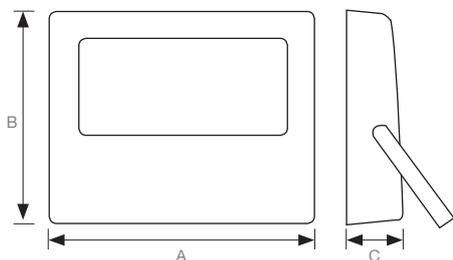

Acabamento • Finishing • Finition

- Branco Mate
 Matt White
 Blanc Mat

DOURO

Descrição • Description • Description

O projector Douro, é um equipamento compacto e económico, concebido para instalações exteriores. Os níveis de luz obtidos, permitem uma ampla gama de aplicações de iluminação quer na área de segurança com circuitos de CCTV, quer na área decorativa com o varrimento de paredes e fachadas de monumentos. Disponível em potências entre 10W e 100W.

Designed for outdoor installations, the Douro flood light is compact and economical. The light levels obtained allows a wide range of lighting applications, both in the security area with CCTV circuits and in the decorative area with the scanning of walls and facades of monuments. Available in powers between 10W and 100W.

Conçu pour les installations extérieures, la lumière Douro est compacte et économique. Les niveaux lumineux obtenus permettent un large éventail d'applications d'éclairage, tant dans la zone de sécurité avec circuits de vidéosurveillance que dans la zone décorative avec le balayage des murs et pour façades de monuments. Disponible en puissance entre 10W et 100W.

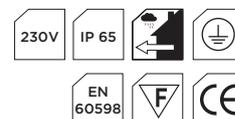

Difusor • Diffuser • Diffuseur

Vidro Temperado Transparente
Clear Tempered Glass
Verre Trempé Clair

Lâmpadas • Lamps • Lampes

LED 3000K, 4200K, 6000K

Douro	A (mm)	B (mm)	C (mm)	Lumens
10 W	85	115	32	900 lm
20 W	136	180	37	1800 lm
30 W	185	225	45	2700 lm
50 W	233	280	60	4500 lm
100 W	280	355	90	9000 lm

Douro	3000K	4200K	6000K
10 W	•	•	•
20 W	•	•	•
30 W	•	•	•
50 W	•	•	•
100 W	-	•	•

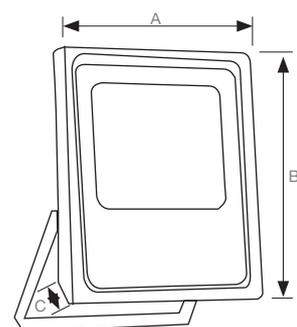

Acabamento • Finishing • Finition

Preto Mate
Matt Black
Noir Mat



ORION

Descrição • Description • Description

Projector submersível, com corpo em aço inox e vidro temperado transparente. Ideal para utilização em lagos e fontes luminosas. Disponível com suporte para MR16.

Underwater floodlight, with stainless steel body and transparent tempered glass. Ideal for use in lakes and light sources. Available with MR16 support.

Projecteur submersible, avec corps en acier inoxydable et verre trempé transparent. Idéal pour les lacs et les sources lumineuses. Disponible avec support MR16.

Difusor • Diffuser • Diffuseur

Vidro Temperado Transparente
Clear Tempered Glass
Verre Trempé Clair

Lâmpadas • Lamps • Lampes

MR16 Máx. 35W



Exclusivamente para submersão
Underwater use only
Utilisation sous-marine seulement

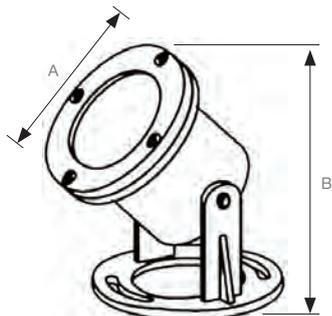
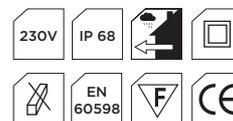

Orion

A (mm)

B (mm)

90

130

Acabamento • Finishing • Finition

■ Aço Inox
Stainless Steel
Acier Inoxydable



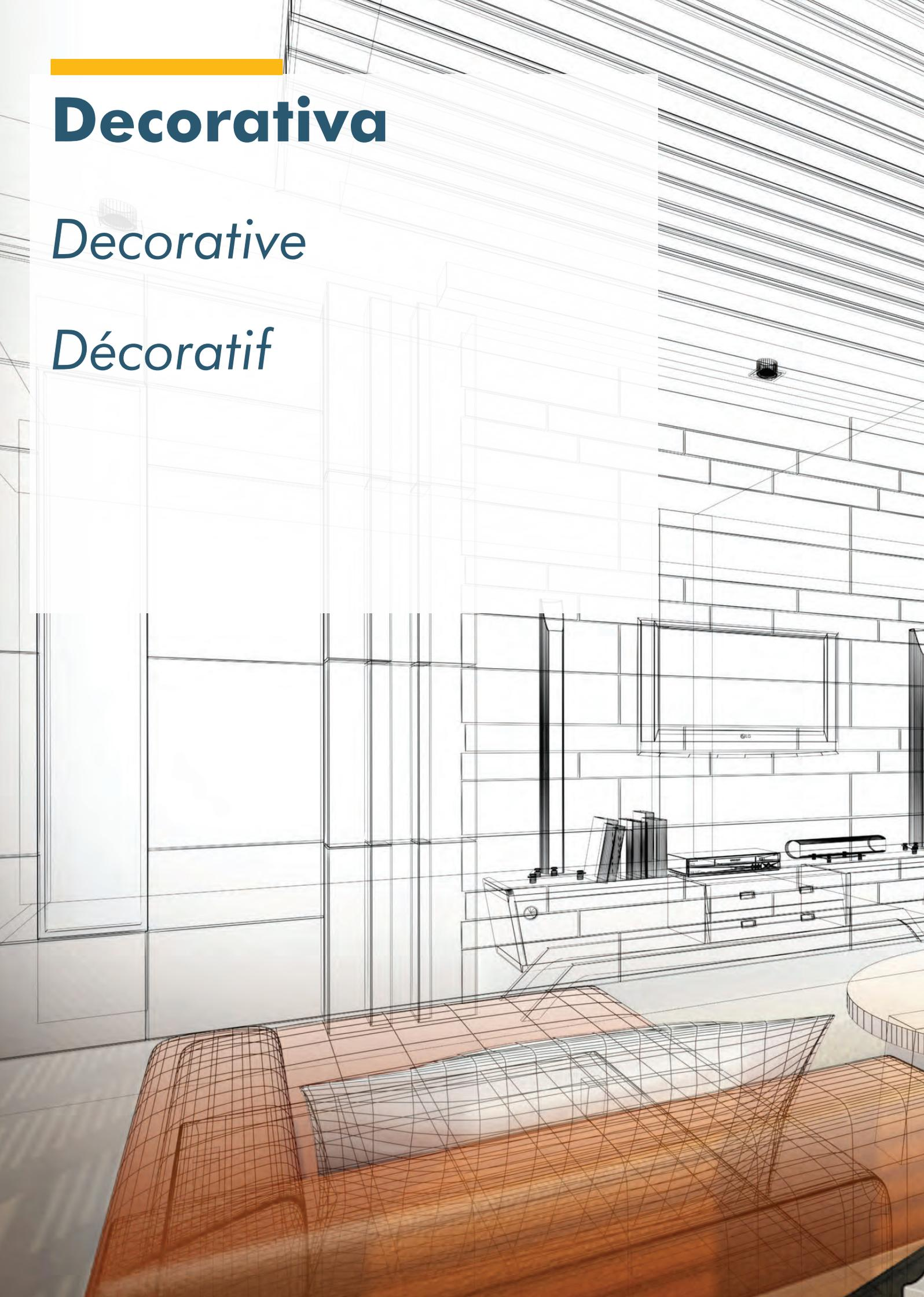

Decorativa

Decorative

Décoratif

Abadia

πάγ. 98

Alpha

πάγ. 105

Alvor

πάγ. 103

Amazonas

πάγ. 114

Amos

πάγ. 110

Anik

πάγ. 138

Artemis

πάγ. 110

Baco

πάγ. 102

Bambola

πάγ. 113

Bonsai

πάγ. 120

Caria

πάγ. 100

Colombia

πάγ. 109

Cosmos

πάγ. 138

Delta B

πάγ. 122

Delta D

πάγ. 122

Disco

πάγ. 140

Draco LED

πάγ. 128

Eclipse

πάγ. 141

Era

πάγ. 104

Galaxy LED

πάγ. 126

Gama

πάγ. 106

Gio

πάγ. 131

Goes

πάγ. 116

Hydra

πάγ. 135

Indus

πάγ. 139

Leo LED

πάγ. 130

Levira

πάγ. 119

Liz

πάγ. 109

Lirio

πάγ. 135

Lotus

πάγ. 101

Luch

πάγ. 114

Mandala

πάγ. 113

Miro I

πάγ. 121

Miro II

πάγ. 121

Mundo Corda

πάγ. 115

Olimpia

πάγ. 106

Omega

πάγ. 105

Optus

πάγ. 116

Ota

πάγ. 101

Pegasus

πάγ. 132

Petros LED

πάγ. 128

Porto

πάγ. 104

Sigma LED

πάγ. 126

Sonata R

πάγ. 124

Sonata Q

πάγ. 124

Souto

πάγ. 99

Space

πάγ. 136

Taurus

πάγ. 133

Vau

πάγ. 98

Yami

πάγ. 119

ABADIA

Descrição • Description • Description

Candeeiro de suspensão, com difusor interior dourado um sóbrio e discreto acabamento em preto mate.

Equipado com suporte E27 e cabo de suspensão com 900mm.

Suspension lamp, with a golden interior reflector and a sober and discreet Matt black finish.

Equipped with E27 stand and suspension cable with 900mm.

Suspension, au réflecteur intérieur doré et extérieur noire mate soignée et sobre.

Equipé d'un culot E27 et d'un câble de suspension avec 900mm.

Difusor • Diffuser • Diffuseur

Dourado
Gold
Doré

Lâmpadas • Lamps • Lampes

Suporte - E27
Lamp Holder - E27
Type de Culot - E27



Acabamento • Finishing • Finition

■ Preto Mate
Matt Black
Noir Mat

VAU

Descrição • Description • Description

Candeeiro de suspensão, com difusor interior dourado um sóbrio e discreto acabamento em preto mate.

Equipado com suporte E27 e cabo de suspensão com 900mm.

Suspension lamp, with a golden interior reflector and a sober and discreet Matt black finish.

Equipped with E27 stand and suspension cable with 900mm.

Suspension, au réflecteur intérieur doré et extérieur noire mate soignée et sobre.

Equipé d'un culot E27 et d'un câble de suspension avec 900mm.

Difusor • Diffuser • Diffuseur

Dourado
Gold
Doré

Lâmpadas • Lamps • Lampes

Suporte - E27
Lamp Holder - E27
Type de Culot - E27



Acabamento • Finishing • Finition

■ Preto Mate
Matt Black
Noir Mat

SOUTO

Descrição • Description • Description

Candeeiro de suspensão com formato inspirado em cúpulas árabes, com elegante acabamento em preto mate e com interior dourado para uma projecção de luz mais confortável.

Equipado com suporte E27 e cabo de suspensão com 900mm.

Suspension lamp with Arabic-inspired design, with elegant Matt black finish and golden interior for a more comfortable light projection. Equipped with E27 stand and suspension cable with 900mm.

Suspension au finition noire mate soignée et sobre et un intérieur doré pour diffuse un magnifique éclairage dans toute les pièces. Equipé d'un support E27 et d'un câble de suspension avec 900mm.

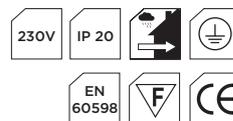

A (mm)	B (mm)
--------	--------

295	350
-----	-----

Difusor • Diffuser • Diffuseur

Dourado
Gold
Doré

Lâmpadas • Lamps • Lampes

Suporte - E27
Lamp Holder - E27
Type de Culot - E27

Acabamento • Finishing • Finition

■ Preto Mate
Matt Black
Noir Mat



CARIA

Descrição • Description • Description

Candeeiro de suspensão com formato inspirado em cúpulas árabes, com elegante acabamento em preto mate e com interior dourado para uma projecção de luz mais confortável.

Equipado com suporte E27 e cabo de suspensão com 900mm.

Suspension lamp with arabic-inspired shape, with elegant Matt black finish and golden interior for a more comfortable light projection. Equipped with E27 stand and suspension cable with 900mm.

Suspension en laiton au forme elliptique, travaillé à la main décoration allusive à l'Afrique du Nord. Equipé de culot E27 et le câble de suspension avec 900mm.

Difusor • Diffuser • Diffuseur

Dourado
Gold
Doré

Lâmpadas • Lamps • Lampes

Suporte - E27
Lamp Holder - E27
Type de Culot - E27



Acabamento • Finishing • Finition

■ Preto Mate
Matt Black
Noir Mat



LOTUS

Descrição • Description • Description

Candeeiro de suspensão com formato inspirado em cúpulas árabes, com elegante acabamento em preto mate e com interior dourado para uma projecção de luz mais confortável.
Equipado com suporte E27 e cabo de suspensão com 900mm.

Suspension lamp with Arabic-inspired design, with elegant Matt black finish and golden interior for a more comfortable light projection. Equipped with E27 stand and suspension cable with 900mm.

Suspension au finition noire mate soignée et sobre et un intérieur doré pour diffuse un magnifique éclairage dans toute les pièces. Equipé d'un support E27 et d'un câble de suspension avec 900mm.

Difusor • Diffuser • Diffuseur

Dourado
Gold
Doré

Lâmpadas • Lamps • Lampes

Suporte - E27
Lamp Holder - E27
Type de Culot - E27

OTA

Descrição • Description • Description

Candeeiro de suspensão com elegante acabamento em preto mate e com interior dourado para uma projecção de luz mais confortável.
Equipado com suporte E27 e cabo de suspensão com 900mm.

Suspension lamp with elegant Matt black finish and golden interior for a more comfortable light projection. Equipped with E27 stand and suspension cable with 900mm.

Lampe à suspension au finition élégante noire mate et à l'intérieur d'or pour diffuse un magnifique éclairage dans les pièces. Equipé avec culot et le câble de suspension avec 900mm.

Difusor • Diffuser • Diffuseur

Dourado
Gold
Doré

Lâmpadas • Lamps • Lampes

Suporte - E27
Lamp Holder - E27
Type de Culot - E27



Acabamento • Finishing • Finition

■ Preto Mate
Matt Black
Noir Mat



Acabamento • Finishing • Finition

■ Preto Mate
Matt Black
Noir Mat

BACO

Descrição • Description • Description

Candeeiro de suspensão, de formato elíptico com difusor interior dourado um sóbrio e discreto acabamento em preto mate. Equipado com suporte E27 e cabo de suspensão com 900mm.

Suspension lamp, elliptical in shape with a golden interior reflector and with a sober and discreet Matt black finish. Equipped with E27 stand and suspension cable with 900mm.

Suspension elliptique au réflecteur en finition intérieure d'or et extérieure noire mate, sobre et discrète. Equipé avec culot E27 et le câble de suspension avec 900mm.

Difusor • Diffuser • Diffuseur

Dourado
Gold
Doré

Lâmpadas • Lamps • Lampes

Suporte - E27
Lamp Holder - E27
Type de Culot - E27



Acabamento • Finishing • Finition

■ Preto Mate
Matt Black
Noir Mat





ALVOR

Descrição • Description • Description

Candeeiro de suspensão com acabamento sóbrio e discreto em preto mate e interior em branco para uma óptima reflexão de luz. Equipado com suporte E27 e cabo de suspensão com 900mm.

Suspension lamp with a sober and discreet Matt black finish and a bright white interior for optimal reflection of light. Equipped with E27 stand and suspension cable with 900mm.

Suspension au finition noire mate soignée et sobre et un intérieur blanc brillant pour diffuse un magnifique éclairage dans tous les pièces. Equipé d'un support E27 et d'un câble de suspension avec 900mm.

Difusor • Diffuser • Diffuseur

Branco Brilhante
Bright White
Blanc Brillant

Lâmpadas • Lamps • Lampes

Suporte - E27
Lamp Holder - E27
Type de Culot - E27



Acabamento • Finishing • Finition

Preto Mate
Matt Black
Noir Mat

PORTO

Descrição • Description • Description

Candeeiro de suspensão com acabamento sóbrio e discreto em preto mate e interior em branco para uma óptima reflexão de luz. Equipado com suporte E27 e cabo de suspensão com 900mm.

Suspension lamp with a sober and discreet Matt black finish and a bright white interior for optimal reflection of light. Equipped with E27 stand and suspension cable with 900mm.

Suspension au finition noire mate soignée et sobre et un intérieur blanc brillant pour diffuse un magnifique éclairage dans tous les pièces. Equipé d'un support E27 et d'un câble de suspension avec 900mm.

Difusor • Diffuser • Diffuseur

Branco Brilhante
Bright White
Blanc Brillant

Lâmpadas • Lamps • Lampes

Suporte - E27
Lamp Holder - E27
Type de Culot - E27

ERA

Descrição • Description • Description

Candeeiro de suspensão com acabamento sóbrio e discreto em preto mate e interior em branco para uma óptima reflexão de luz. Equipado com suporte E27 e cabo de suspensão com 900mm.

Suspension lamp with a sober and discreet Matt black finish and a bright white interior for optimal reflection of light. Equipped with E27 stand and suspension cable with 900mm.

Suspension au finition noire mate soignée et sobre et un intérieur blanc brillant pour diffuse un magnifique éclairage dans toute les pièces. Equipé d'un support E27 et d'un câble de suspension avec 900mm.

Difusor • Diffuser • Diffuseur

Branco Brilhante
Bright White
Blanc Brillant

Lâmpadas • Lamps • Lampes

Suporte - E27
Lamp Holder - E27
Type de Culot - E27



A

B

A (mm)	B (mm)
185	380

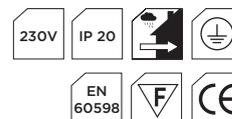

Acabamento • Finishing • Finition

■ Preto Mate
Matt Black
Noir Mat



A

B

A (mm)	B (mm)
295	360

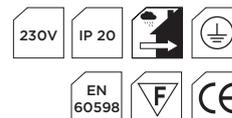

Acabamento • Finishing • Finition

■ Preto Mate
Matt Black
Noir Mat

ALPHA

Descrição • Description • Description

Candeeiro de suspensão de formato elíptico em latão trabalhado com decoração alusiva a África do Norte.

Equipado com suporte E27 e cabo de suspensão com 900mm.

Elliptical shaped suspension lamp with forged/beaten Brass decoration typical of North Africa.

Equipped with E27 stand and suspension cable with 900mm.

Suspension en laiton au forme elliptique, travaillé à la main décoration allusive à l'Afrique du Nord. Equipé de culot E27 et le câble de suspension avec 900mm.

Difusor • Diffuser • Diffuseur

Branco Brilhante
Bright White
Blanc Brillant

Lâmpadas • Lamps • Lampes

Suporte - E27
Lamp Holder - E27
Type de Culot - E27

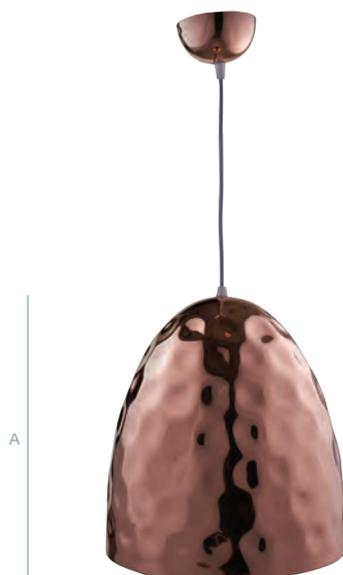

B

A (mm) B (mm)

300 305

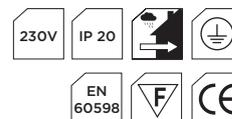

Acabamento • Finishing • Finition



Latão
Brass
Laiton

OMEGA

Descrição • Description • Description

Candeeiro de suspensão de formato elíptico em latão trabalhado com decoração alusiva a África do Norte.

Equipado com suporte E27 e cabo de suspensão com 900mm.

Elliptical shaped suspension lamp with forged/beaten Brass decoration typical of North Africa.

Equipped with E27 stand and suspension cable with 900mm.

Suspension en laiton au forme elliptique, travaillé à la main décoration allusive à l'Afrique du Nord. Equipé de culot E27 et le câble de suspension avec 900mm.

Difusor • Diffuser • Diffuseur

Branco Brilhante
Bright White
Blanc Brillant

Lâmpadas • Lamps • Lampes

Suporte - E27
Lamp Holder - E27
Type de Culot - E27



B

A (mm) B (mm)

155 300



Acabamento • Finishing • Finition



Latão
Brass
Laiton

GAMA

Descrição • Description • Description

Candeeiro de suspensão em latão trabalhado com decoração típica da África do Norte. Equipado com suporte E27 e cabo de suspensão com 900mm.

Suspension lamp with decoration in forged/ beaten brass typical of North Africa. Equipped with E27 stand and suspension cable with 900mm.

Suspension en laiton au forme elliptique, travaillé à la main décoration allusive à l'Afrique du Nord. Equipé de culot E27 et le câble de suspension avec 900mm.

Difusor • Diffuser • Diffuseur

Branco Brilhante
Bright White
Blanc Brillant

Lâmpadas • Lamps • Lampes

Suporte - E27
Lamp Holder - E27
Type de Culot - E27

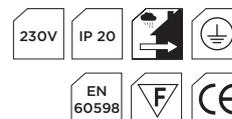
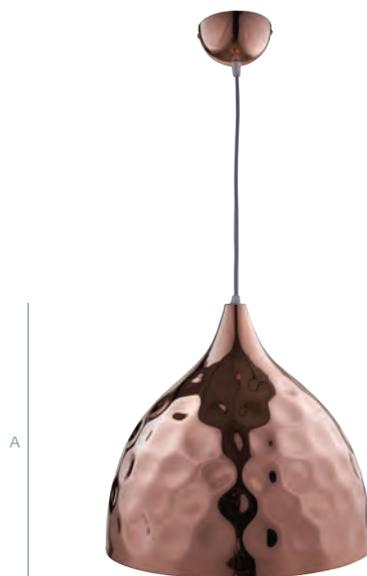

A (mm)	B (mm)
330	355

Acabamento • Finishing • Finition



Latão
Brass
Laiton

OLIMPIA

Descrição • Description • Description

Armadura de campânula, em policarbonato translúcido, de design contemporâneo para espaços interiores domésticos ou comerciais. Equipada com suporte E27 e cabo de suspensão com 900mm.

Translucent polycarbonate bell fixture, contemporary design for domestic or commercial interior spaces. Equipped with E27 stand and suspension cable with 900mm.

Cloche en polycarbonate translucide, design contemporain pour espaces intérieurs tertiaires. Equipé d'un culot E27 et d'un câble de suspension avec 900mm.

Difusor • Diffuser • Diffuseur

Branco Brilhante
Bright White
Blanc Brillant

Lâmpadas • Lamps • Lampes

Suporte - E27
Lamp Holder - E27
Type de Culot - E27



A (mm)	B (mm)
195	255

Acabamento • Finishing • Finition



Polycarbonato Translúcido
Translucent Polycarbonate
Polycarbonate Translucide





LIZ

Descrição • Description • Description

Candeeiro de suspensão de formato elíptico de design e cores "retro" com linhas simples e elegantes. Acabamento em azul esmalte e interior em branco para óptima reflexão de luz. Equipado com suporte E27 e cabo de suspensão com 900mm.

Elliptical shaped pendant lamp with simple and elegant lines "retro" design. Finished in blue glaze and bright white interior for optimal reflection of light. Equipped with E27 stand and suspension cable with 900mm.

Pendentif elliptique au lignes sobres et élégantes conception "rétro". Finition intérieur en blanc et extérieur bleu, idéale pour diffuser un magnifique éclairage. Equipé avec culot E27 et le câble de suspension avec 900mm.

Difusor • Diffuser • Diffuseur

Branco Brilhante
Bright White
Blanc Brillant

Lâmpadas • Lamps • Lampes

Suporte - E27
Lamp Holder - E27
Type de Culot - E27

COLOMBIA

Descrição • Description • Description

Candeeiro de suspensão com acabamento sóbrio e discreto em preto mate e interior em branco para uma óptima reflexão de luz. Equipado com suporte E27 e cabo de suspensão com 900mm.

Suspension lamp with a sober and discreet Matt black finish and a bright white interior for optimal reflection of light. Equipped with E27 stand and suspension cable with 900mm.

Suspension au finition noire mate soignée et sobre et un intérieur blanc brillant pour diffuse un magnifique éclairage dans toute les pièces. Equipé d'un support E27 et d'un câble de suspension avec 900mm.

Difusor • Diffuser • Diffuseur

Branco Brilhante
Bright White
Blanc Brillant

Lâmpadas • Lamps • Lampes

Suporte - E27
Lamp Holder - E27
Type de Culot - E27

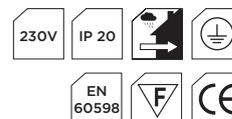

A (mm)	B (mm)
260	320

Acabamento • Finishing • Finition

■ Azul Esmalte
Glaze Blue
Bleu Email

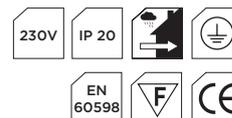

A (mm)	B (mm)
285	300

Acabamento • Finishing • Finition

■ Vermelho Esmalte
Glaze Red
Rouge Email

AMOS

Descrição • Description • Description

Candeeiro suspenso com vertente decorativa muito vincada, ideal para espaços comerciais, cozinhas.

Equipado com suporte E27 e cabo de suspensão com 900mm.

Suspended lamp with a decorative image, ideal for commercial spaces, kitchens. Equipped with E27 stand and suspension cable with 900mm.

Suspension avec image décorative, idéale pour les espaces commerciaux; cafés, Bistrôs et restaurants.

Equipé d'un culot E27 et d'un câble de suspension avec 900mm.

Difusor • Diffuser • Diffuseur

PVC Branco
White PVC
PVC Blanc

Lâmpadas • Lamps • Lampes

Suporte - 3xE27
Lamp Holder - 3xE27
Type de Culot - 3xE27

ARTEMIS

Descrição • Description • Description

Candeeiro suspenso com vertente decorativa muito vincada, ideal para espaços comerciais, cozinhas.

Equipado com suporte E27 e cabo de suspensão com 900mm.

Suspended lamp with a decorative image, ideal for commercial spaces, kitchens. Equipped with E27 stand and suspension cable with 900mm.

Suspension avec image décorative, idéale pour espaces commerciaux; cafés, Bistrôs et restaurants.

Equipé d'un culot E27 et le câble de suspension avec 900mm.

Difusor • Diffuser • Diffuseur

PVC Branco
White PVC
PVC Blanc

Lâmpadas • Lamps • Lampes

Suporte - E27
Lamp Holder - E27
Type de Culot - E27



Acabamento • Finishing • Finition

Preto Mate
Matt Black
Noire Mat

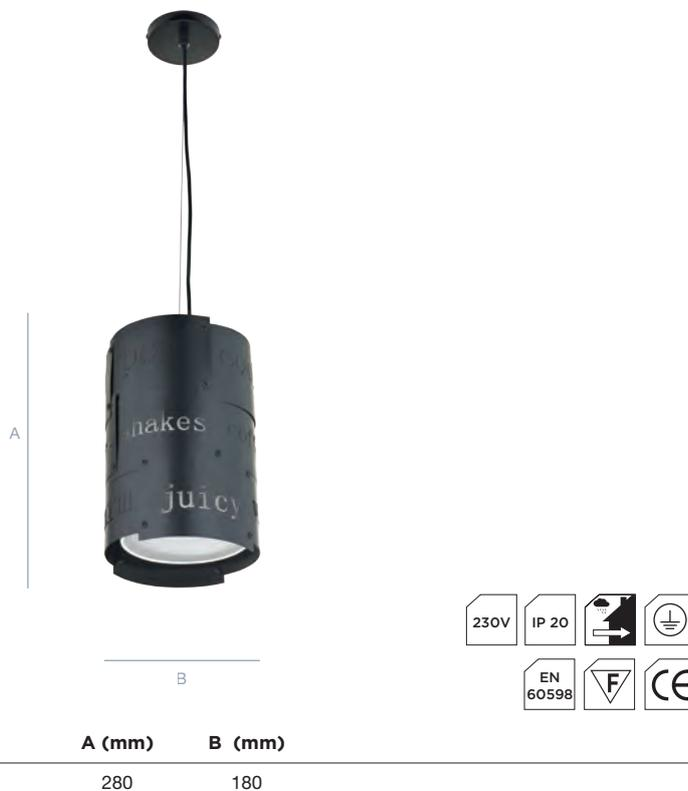

Acabamento • Finishing • Finition

Preto Mate
Matt Black
Noire Mat





BAMBOLA

Descrição • Description • Description

Candeeiro de suspensão, trabalhado em verga de ferro com formato de globo e com cone interior em tecido para uma suave projecção de luz.

Equipado com suporte E27 e cabo de suspensão com 900mm.

Suspension lamp, worked in globe-shaped iron rod and with inner cone in fabric for a soft projection of light.

Equipped with E27 stand and suspension cable with 900mm.

Suspension, travaillée en tige de fer en forme de globe aux cônes intérieurs en tissu pour une projection de lumière très agréable.

Equipé d'un culot E27 et d'un câble de suspension avec 900mm.

Difusor • Diffuser • Diffuseur

Tecido
Fabric
Tissu

Lâmpadas • Lamps • Lampes

Suporte - E27
Lamp Holder - E27
Type de Culot - E27

MANDALA

Descrição • Description • Description

Elegante candeeiro suspenso, com armação exterior em forma de gota e com cone interior em tecido para uma suave projecção de luz.

Equipado com suporte E27 e cabo de suspensão com 900mm.

Elegant pendant lamp, with drop-shaped outer frame and inner fabric cone for a soft light projection.

Equipped with E27 stand and suspension cable with 900mm.

Élégante lampe de suspension, linhe en forme de goutte deau et cône de tissu intérieur pour crée una ambiance domestique très agréable.

Equipé d'un culot E27 et d'un câble de suspension avec 900mm.

Difusor • Diffuser • Diffuseur

Tecido
Fabric
Tissu

Lâmpadas • Lamps • Lampes

Suporte - E27
Lamp Holder - E27
Type de Culot - E27



AMAZONAS

Descrição • Description • Description

Candeeiro de suspensão de forma esférica elaborado com fio metálico armado. Ideal para decoração de espaços comerciais e temáticos.
Equipado com 6 suportes E14 e cabo de suspensão com 900mm.

Suspension lamp in spherical shape made with reinforced metallic wire. Ideal for decoration of commercial and thematic spaces. Equipped with 6 E14 lamp holder and suspension cable with 900mm.

Lampe de suspension en forme de sphère en fil métallique renforcé. Idéal pour la décoration d'espaces commerciaux et thématiques. Équipé d'un culot E14 et d'un câble de suspension avec 900mm.

Difusor • Diffuser • Diffuseur

Fio Metálico
Metallic Wire
Fil Métallique

Lâmpadas • Lamps • Lampes

Suporte - 6xE14
Lamp Holder - 6xE14
Type de Culot - 6xE14

LUCH

Descrição • Description • Description

Candeeiro em vidro com suspensão decorativa com motivos de aço forjado.
Equipado com suporte E27.

Glass lamp with decorative suspension with forged steel motifs. Equipped with E27.

Lampe en verre avec suspension décorative en acier forgé. Équipé d'un culot E27.

Difusor • Diffuser • Diffuseur

Vidro Transparente
Clear Glass
Verre Claire

Lâmpadas • Lamps • Lampes

Suporte - E27
Lamp Holder - E27
Type de Culot - E27



A (mm)

500

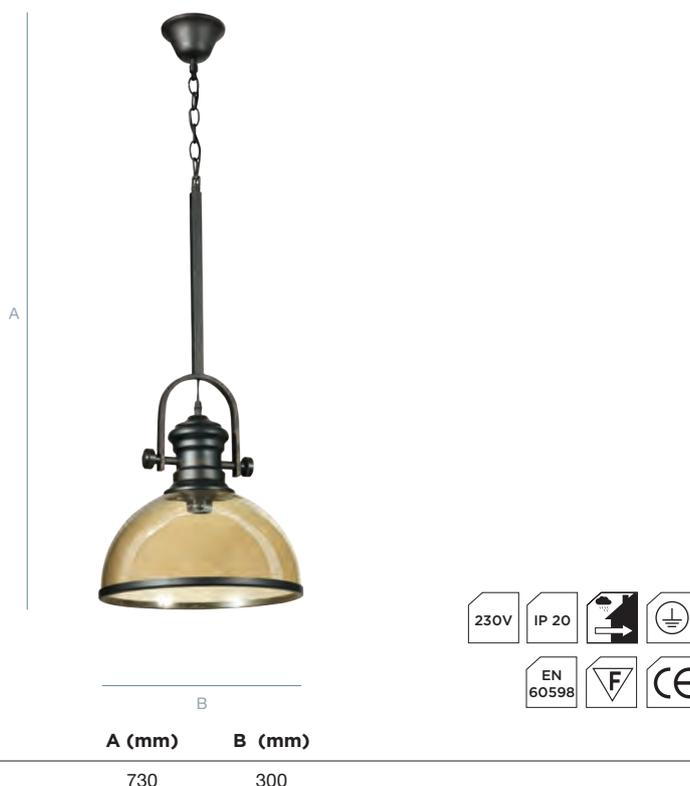

A (mm) B (mm)

730

300

MUNDO CORDA

Descrição • Description • Description

Candeeiro de suspensão de formato em esfera aberta, elaborado com corda de sisal, ideal para decoração de espaços comerciais. Equipado com suporte E14 e cabo de suspensão com 900mm.

Open sphere suspension lamp, made with sisal rope, ideal for decoration of commercial spaces.

Equipped with E14 stand and suspension cable with 900mm.

Suspension en sphère, faite avec une corde de sisal, idéal pour décoration des espaces commerciaux.

Equipé avec culot E14 et le câble de suspension avec 900mm.

Lâmpadas • Lamps • Lampes

Suporte - 3xE14
Lamp Holder - 3xE14
Type de Culot - 3xE14



A (mm)

550

Acabamento • Finishing • Finition

 Corda Sisal
Sisal Rope
Corde Sisal



OPTUS

Descrição • Description • Description

Candeeiro de parede composto com motivos hidráulicos para decoração de espaços comerciais.

Equipado com suporte E27.

*Wall lamp with pipelines decoration of commercial spaces.
Equipped with E27 lamp holder.*

*Lampe murale en forme de plomberie pour décoration d'espaces commerciaux.
Équipé d'un culot E27.*



Lâmpadas • Lamps • Lampes

Suporte - E27

Lamp Holder - E27

Type de Culot - E27

A (mm) **B (mm)**

165 170

GOES

Descrição • Description • Description

Candeeiro de parede composto com motivos hidráulicos para decoração de espaços comerciais.

Equipado com suporte 2 x E27.

*Wall lamp with pipelines decoration of commercial spaces.
Equipped with 2 x E27 lamp holder.*

*Lampe murale en forme de plomberie pour décoration d'espaces tertiare.
Équipé de 2 x culot E27.*



Lâmpadas • Lamps • Lampes

Suporte - 2xE27

Lamp Holder - 2xE27

Type de Culot - 2xE27

A (mm) **B (mm)**

140 200





YAMI

Descrição • Description • Description

Candeeiro de suspensão composto com motivos hidráulicos para decoração de espaços comerciais.
Equipado com 3 suportes E27.

*Suspension lamp with pipelines decoration of commercial spaces.
Equipped with 3 E27.*

*Suspension au design de gros tyaux de plomberie pour espaces commerciaux.
Équipé de 3 culot E27.*

Lâmpadas • Lamps • Lampes

Suporte - 3xE27
Lamp Holder - 3xE27
Type de Culot - 3xE27

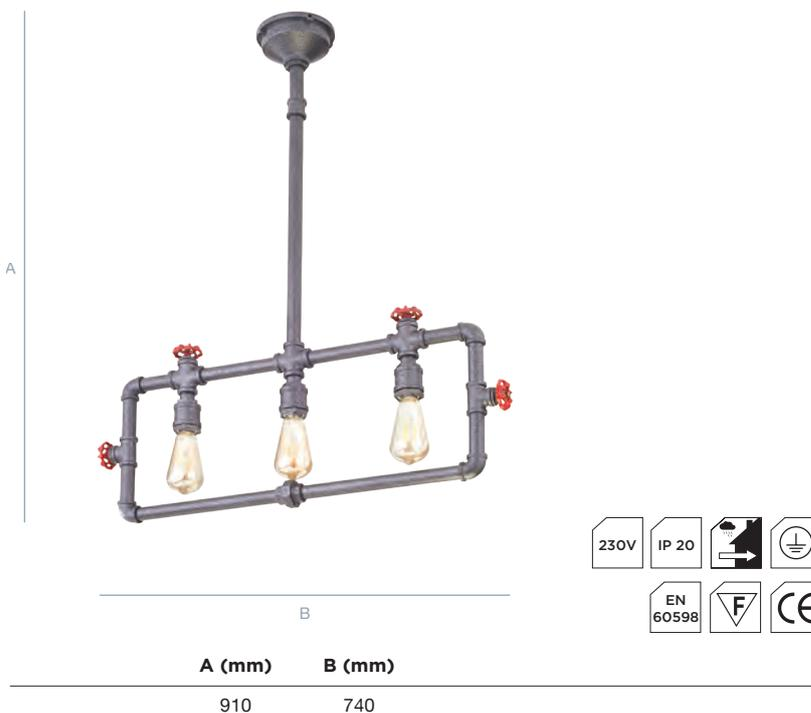

Acabamento • Finishing • Finition

Cinza
Grey
Gris

LEVIRA

Descrição • Description • Description

Candeeiro de parede composto com motivos hidráulicos para decoração de espaços comerciais.
Equipado com suporte E27.

*Wall lamp with pipelines decoration of commercial spaces.
Equipped with E27 lamp holder.*

*Lampe murale en forme de plomberie pour décoration d'espaces tertiaires.
culot E27.*

Lâmpadas • Lamps • Lampes

Suporte - E27
Lamp Holder - E27
Type de Culot - E27



BONSAI

Descrição • Description • Description

Candeeiro de parede feito de bambu, com vertente decorativa muito vincada, ideal para espaços comerciais, como Spa, clínicas, ginásios, balneários. Equipado com suporte E14.

Bamboo Wall lamp, with decorative design, ideal for commercial spaces such as Spa, clinics, gymnasiums, health resorts. Equipped with E14 lamp holder.

Lampe murale en bambou, avec design décoratif, idéal pour les espaces commerciaux tels que Spa, cliniques, gymnases, stations thermales.



Lâmpadas • Lamps • Lampes

Suporte - E14
Lamp Holder - E14
Type de Culot - E14

A (mm)	B (mm)
350	80



MIRO I

Descrição • Description • Description

Candeeiro led de design elegante, para aplicação em áreas de leitura como púlpitos e em parede possibilitando assim novas opções de iluminação de quadros, telas, fotos ou pormenores decorativos.

Led lamp of elegant design, for application in reading areas such as pulpits and walls allowing new options for paintings lighting, photos or decorative details.

Lampe led, design élégant, pour une utilisation dans des domaines tels que de nouvelles options pour l'éclairage des tableaux, des écrans, des photos ou des détails décoratifs.



Lâmpadas • Lamps • Lampes

LED 5W - 6000K
LED 9W - 6000K

Miro I	A (mm)	B (mm)	Lumens
5W	450	130	400lm
9W	585	140	750lm

Acabamento • Finishing • Finition



MIRO II

Descrição • Description • Description

Candeeiro led de design elegante, para aplicação em áreas de leitura como púlpitos e em parede possibilitando assim novas opções de iluminação de quadros, telas, fotos ou pormenores decorativos.

Led lamp of elegant design, for application in reading areas such as pulpits and walls allowing new options for paintings lighting, photos or decorative details.

Lampe led, design élégant, pour une utilisation dans des domaines tels que de nouvelles options pour l'éclairage des tableaux, des écrans, des photos ou des détails décoratifs.



Lâmpadas • Lamps • Lampes

LED 7W - 6000K

Miro II	A (mm)	B (mm)	Lumens
7W	430	120	400lm

Acabamento • Finishing • Finition



DELTA B

Descrição • Description • Description

Projector orientável em alumínio.

Adjustable aluminum spotlight.

Projecteur rotatif en aluminium.

Lâmpadas • Lamps • Lampes

LED 1W - 4000K



DELTA B	A (mm)	B (mm)	Lumens
1W	73	370	90lm

Acabamento • Finishing • Finition



DELTA D

Descrição • Description • Description

Projector orientável em alumínio.

Adjustable aluminum spotlight.

Projecteur rotatif en aluminium.

Lâmpadas • Lamps • Lampes

LED 1W - 4000K

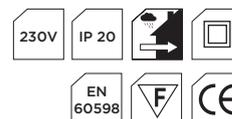

DELTA D	A (mm)	B (mm)	Lumens
1W	73	335	90lm

Acabamento • Finishing • Finition





SONATA R

Descrição • Description • Description

Candeeiro redondo de suspensão, de design inovador constituído por traços estilizados e elegantes. Com um acabamento em cinza mate, que o torna ideal para a decoração de espaços interiores.

Round suspension lamp, innovative design with stylish and elegant features. With a Matt grey finish, it makes it ideal for interior decoration.

Suspension rond innovante composé d'une ligne sobre et élégante. Finition en Gris Mat, elle est idéale pour la décoration intérieure.

Difusor • Diffuser • Diffuseur

Acrílico Fosco
Frosted Acrylic
Acrylique Opaline

Lâmpadas • Lamps • Lampes

LED 3000K/6000K



Triple II

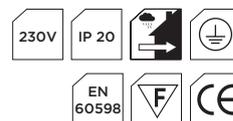

SONATA	A (mm)	B (mm)	C (mm)
R 140	180	850	400
R 150	180	850	500
R 160	180	850	600
R 180	250	850	800
Triple I	300	850	400+500+600
Triple II	300	850	400+600+800

Acabamento • Finishing • Finition

Cinza Mate
Matt Grey
Gris Mat

SONATA Q

Descrição • Description • Description

Candeeiro quadrado de suspensão, de design inovador constituído por traços estilizados e elegantes. Com um acabamento em cinza mate, que o torna ideal para a decoração de espaços interiores.

Square suspension lamp, innovative design with stylish and elegant features. With a Matt grey finish, it makes it ideal for interior decoration.

Suspension carré innovante composé d'une ligne sobre et élégante. Finition en Gris Mat, elle est idéale pour la décoration intérieure.

Difusor • Diffuser • Diffuseur

Acrílico Fosco
Frosted Acrylic
Acrylique Opaline

Lâmpadas • Lamps • Lampes

LED 3000K/6000K

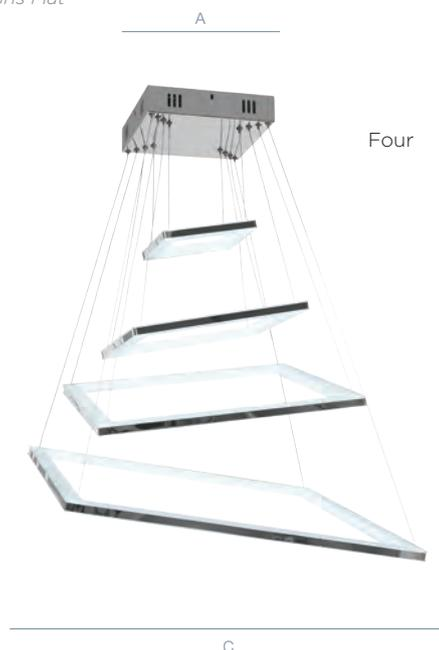

Four



SONATA	A (mm)	B (mm)	C (mm)
Q 118	125	850	180
Q 132	160	850	320
Q 146	180	850	460
Q 160	200	850	600
Four	300	850	180+320+460+600

Acabamento • Finishing • Finition

Cromado
Chrome
Chromé



SIGMA LED

Descrição • Description • Description

Candeeiro de suspensão, de design inovador constituído por traços estilizados e elegantes. Com um acabamento cromado, que o torna ideal para a decoração de espaços interiores.

Suspension lamp, innovative design with stylish and elegant features. With a chrome finish, it makes it ideal for interior decoration.

Suspension innovante, composé d'une ligne sobre et élégante. Finition en chromé, elle est idéale pour la décoration intérieure.

Difusor • Diffuser • Diffuseur

Acrílico Fosco
Frosted Acrylic
Acrylique Opaline

Lâmpadas • Lamps • Lampes

LED 67W - 3000K

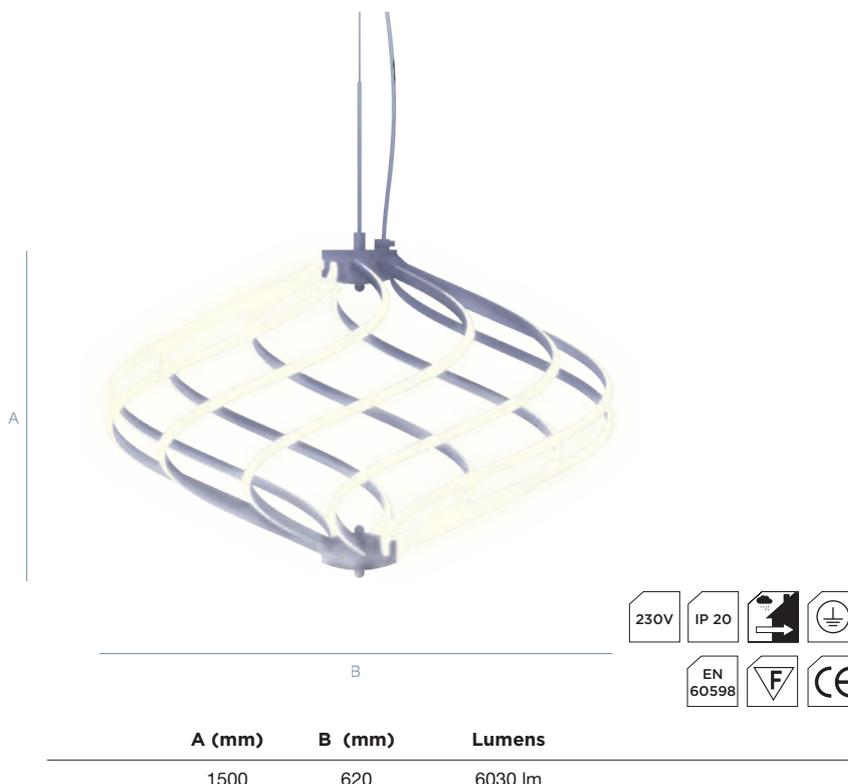

Acabamento • Finishing • Finition

 Cromado
Chrome
Chromé

GALAXY LED

Descrição • Description • Description

Candeeiro de suspensão, de design inovador constituído por traços estilizados e elegantes. Com um acabamento em Prata Escovada, que o torna ideal para a decoração de espaços interiores.

Suspension lamp, innovative design with stylish and elegant features. With a Sandy Silver finish, it makes it ideal for interior decoration.

Suspension innovante composé d'une ligne sobre et élégante. Finition en Gris Argenté, elle est idéale pour la décoration intérieure.

Difusor • Diffuser • Diffuseur

Acrílico Fosco
Frosted Acrylic
Acrylique Opaline

Lâmpadas • Lamps • Lampes

LED 67W - 3000K



Acabamento • Finishing • Finition

 Prata Escovada
Sandy Silver
Gris Argenté



DRACO LED

Descrição • Description • Description

Candeeiro de suspensão de design inovador constituído por um conjunto de linhas simples e elegantes. Com um acabamento em branco, que lhe permite uma integração harmoniosa com qualquer tipo de decoração.

Suspension lamp with innovative design consisting of a set of simple and elegant lines. With a white finish, it allows a harmonious integration with any type of decoration.

Suspension fascinante au design de lignes enlacées, sobre et élégantes. Finition en blanc, qui permet une intégration harmonieuse avec n'importe quel type de pièce.



Difusor • Diffuser • Diffuseur

Acrílico Fosco
Frosted Acrylic
Acrylique Opaline

Lâmpadas • Lamps • Lampes

LED 80W - 3500K

A (mm)	B (mm)	Lumens
1500	520	7200 lm

Acabamento • Finishing • Finition

Branco Mate
Matt White
Blanc Mat

PETROS LED

Descrição • Description • Description

Candeeiro de suspensão, de design inovador constituído por traços estilizados e elegantes. Com um acabamento em bronze, que o torna ideal para a decoração de espaços interiores.

Suspension lamp, innovative design with stylish and elegant features. With a bronze finish, it makes it ideal for interior decoration.

Suspension innovante, composé d'une ligne sobre et élégante. Finition en bronze, elle est idéal pour la décoration intérieur.



Difusor • Diffuser • Diffuseur

Acrílico Fosco
Frosted Acrylic
Acrylique Opaline

Lâmpadas • Lamps • Lampes

LED 20W - 3000K

A (mm)	B (mm)	Lumens
1200	1080	1800 lm

Acabamento • Finishing • Finition

Cromado
Chrome
Chromé





LEO LED

Descrição • Description • Description

Candeeiro de suspensão, de design inovador constituído por um traço estilizado simples e elegante. Com um acabamento em bronze, que o torna ideal para a decoração de espaços interiores.

Suspension lamp, innovative design consisting of a simple and elegant stylized line. With a bronze finish, it makes it ideal for interior decoration.

Suspension innovante composé d'une ligne sobre et élégante. Finition en bronze, elle est idéale pour la décoration intérieure.



Difusor • Diffuser • Diffuseur

Acrílico Fosco
Frosted Acrylic
Acrylique Opaline

Lâmpadas • Lamps • Lampes

LED 20W - 3000K

A (mm)	B (mm)	Lumens
1200	650	1800 lm

Acabamento • Finishing • Finition

 Bronze Vermelho
 Red Bronze
 Rouge Bronze

GIO LED

Descrição • Description • Description

Candeeiro de mesa de design simples e elegante com acabamento cromado, que se adapta a qualquer tipo de decoração.

Table lamp with a simple and elegant design with chrome finish, that adapts to any type of decoration.

Cette lampe de table au design simple et élégante de finition chrome s'adapte à tout type de pièce.

Difusor • Diffuser • Diffuseur

Acrílico Fosco
Frosted Acrylic
Acrylique Opaline

Lâmpadas • Lamps • Lampes

LED 12W - 3000K



A (mm)	B (mm)	Lumens
450	100	1080 lm

Acabamento • Finishing • Finition



PEGASUS LED

Descrição • Description • Description

Candeeiro de chão, com acabamento em prata escovada, de design inovador representado por traço estilizado.

Floor lamp, with sandy silver finish, represented by stylized innovative design.

Lampadaire, finition en acier brossé, design innovant représenté par un style de tiret en formes courbes.

Difusor • Diffuser • Diffuseur

Acrílico Fosco
Frosted Acrylic
Acrylique Opaline

Lâmpadas • Lamps • Lampes

LED 30W - 3000K

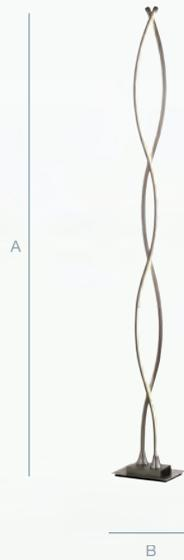

A (mm)	B (mm)	Lumens
1510	200	2700 lm

Acabamento • Finishing • Finition

Prata Escovada
Sandy Silver
Gris Argenté



TAURUS LED

Descrição • Description • Description

Candeeiro de mesa de design inovador constituído por traços estilizados e elegantes. Acabamento cromado, que se adapta a qualquer tipo de decoração.

Table lamp with innovative design with stylish and elegant features. Chrome finish, which fits to any type of decoration.

Cette Lampe de table aux formes courbées de design elegant finition chrome, qui s'adapte à tout type de piece.

Difusor • Diffuser • Diffuseur

Acrílico Fosco
Frosted Acrylic
Acrylique Opaline

Lâmpadas • Lamps • Lampes

LED 15W - 3000K

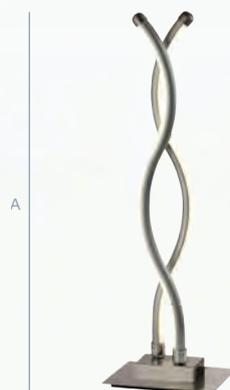

A (mm)	B (mm)	Lumens
490	450	1350 lm

Acabamento • Finishing • Finition



Cromado
Chrome
Chromé



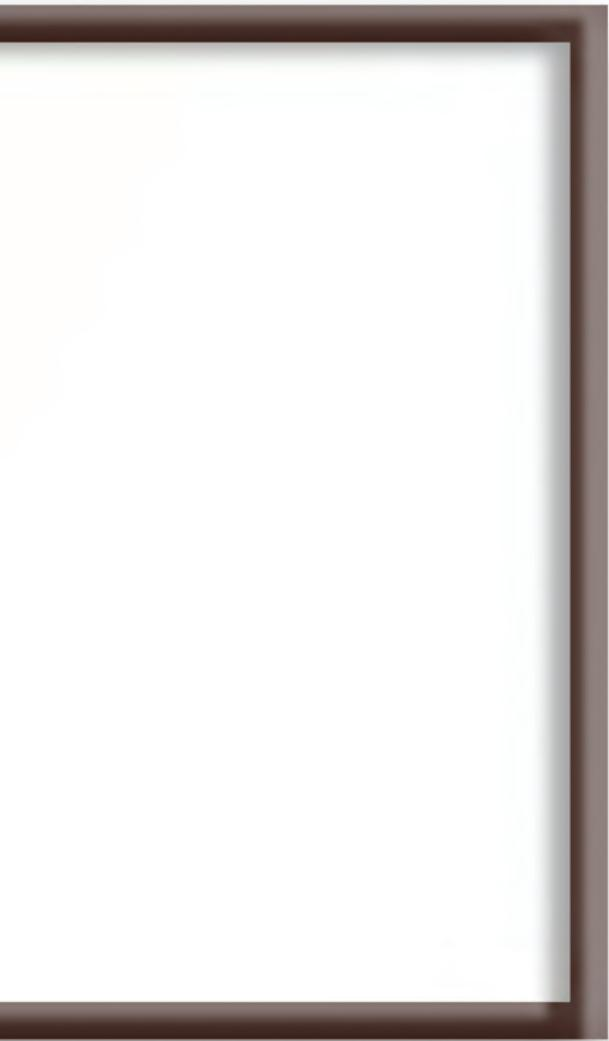

HYDRA LED

Descrição • Description • Description

Candeeiro de chão, com acabamento em bronze vermelho, de design inovador representado por traço estilizado torcido que lhe permite uma iluminação a 360°.

Floor lamp, with red bronze finish, innovative design represented by a twisted styling that allows 360° illumination.

Lampadaire, finition en bronze rouge, design innovant représenté par un style de courbes qui permet un éclairage 360°.

Difusor • Diffuser • Diffuseur

Acrílico Fosco
Frosted Acrylic
Acrylique Opaline

Lâmpadas • Lamps • Lampes

LED 15W - 2700K



A (mm)	B (mm)	Lumens
1210	150	1300 lm

Acabamento • Finishing • Finition

 Bronze Vermelho
Red Bronze
Rouge Bronze

LIRIO LED

Descrição • Description • Description

Candeeiro de chão, com acabamento em bronze vermelho, de design inovador representado por traço estilizado torcido que lhe permite uma iluminação a 360°.

Floor lamp, with red bronze finish, innovative design represented by a twisted styling that allows 360° illumination.

Lampadaire, finition en bronze rouge, design innovant représenté par un style de courbes qui permet un éclairage 360°.

Difusor • Diffuser • Diffuseur

Acrílico Fosco
Frosted Acrylic
Acrylique Opaline

Lâmpadas • Lamps • Lampes

LED 20W - 3000K

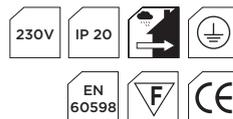

A (mm)	B (mm)	Lumens
1400	230	1800 lm

Acabamento • Finishing • Finition

 Bronze Vermelho
Red Bronze
Rouge Bronze

ANIK LED

Descrição • Description • Description

Candeeiro de mesa de design simples e elegante com acabamento em bronze antigo, que se adapta a qualquer tipo de decoração.

Table lamp with a simple and elegant design with an antique brass finish that adapts to any type of decoration.

Lampe de table au design simple et élégante finition en bronze qui s'adapte à tout type de pièce.

Difusor • Diffuser • Diffuseur

Acrílico Fosco
Frosted Acrylic
Acrylique Opaline

Lâmpadas • Lamps • Lampes

LED 10W - 3000K

SPACE LED

Descrição • Description • Description

Candeeiro de mesa de design simples e elegante com acabamento cromado, que se adapta a qualquer tipo de decoração.

Table lamp with a simple and elegant design with chrome finish that adapts to any type of decoration.

Lampe de table avec un design simple et élégant avec une finition en laiton antique qui s'adapte à tout type de pièce.

Difusor • Diffuser • Diffuseur

Acrílico Fosco
Frosted Acrylic
Acrylique Opaline

Lâmpadas • Lamps • Lampes

LED 10W - 3000K



A (mm)	B (mm)	Lumens
500	180	900 lm

Acabamento • Finishing • Finition

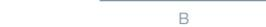
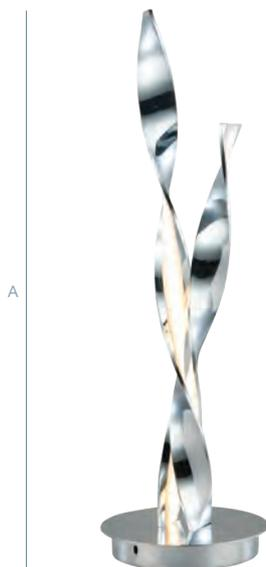

A (mm)	B (mm)	Lumens
500	160	900 lm

Acabamento • Finishing • Finition





COSMOS LED

Descrição • Description • Description

Candeeiro de suspensão, de design inovador constituído por traços estilizados e elegantes. Com um acabamento em Prata Escovada, que o torna ideal para a decoração de espaços interiores.

Suspension lamp, innovative design with stylish and elegant features. With a Sandy Silver finish, it makes it ideal for interior decoration.

Suspension innovante composé d'une ligne sobre et élégante. Finition en Gris Argenté, elle est idéale pour la décoration intérieur.



Difusor • Diffuser • Diffuseur

Acrílico Fosco
Frosted Acrylic
Acrylique Opaline

Lâmpadas • Lamps • Lampes

LED 30W - 3000K

A (mm)	B (mm)	Lumens
970	250	2700 lm

Acabamento • Finishing • Finition





INDUS LED

Descrição • Description • Description

Candeeiro de suspensão circular, de design contemporâneo com suave projecção de luz. Com um acabamento em branco, que lhe permite uma integração harmoniosa com qualquer tipo de decoração.

Circular suspension lamp, contemporary design with a soft projection of light. The white finish, allows a harmonious integration with any type of spaces.

Suspension circulaire, design contemporain, procurent une lumière claire et agréable. La finition blanche permet une intégration harmonieuse avec n'importe quel type de pièces.

Difusor • Diffuser • Diffuseur

Acrílico Fosco
Frosted Acrylic
Acrylique Opaline

Lâmpadas • Lamps • Lampes

LED 10W - 3000K



A (mm)	B (mm)	Lumens
1200	250	810 lm

Acabamento • Finishing • Finition

Branco Mate
Matt White
Blanc Mat

DISCO LED

Descrição • Description • Description

Candeeiro de parede, de design circular com uma projecção de luz muito suave e decorativa. De acabamento em branco mate para uma perfeita integração na maior parte de espaços.

Circular wall lamp design with a very soft and decorative light projection. Matt white finish for perfect integration in most spaces.

Cette lampe murale ronde au lumière très douce et décorative. Finition blanche mat pour une intégration parfaite dans la plupart des espaces.



Difusor • Diffuser • Diffuseur

Acrílico Fosco
Frosted Acrylic
Acrylique Opaline

Lâmpadas • Lamps • Lamps

LED 15W - 3000K

A (mm)	B (mm)	Lumens
300	250	1300 lm

Acabamento • Finishing • Finition

Branco Mate
Matt White
Blanc Mat

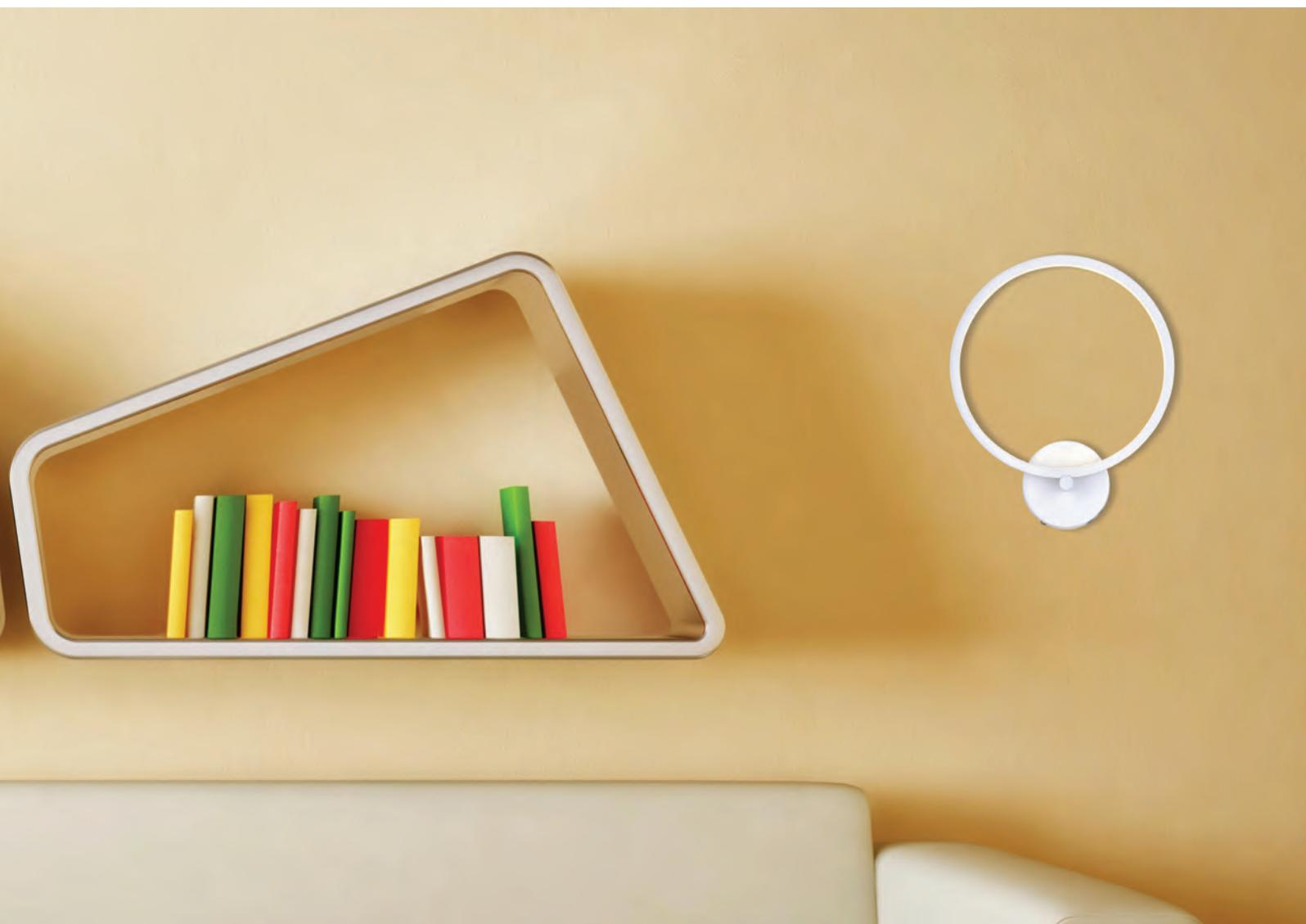



ECLIPSE

Descrição • Description • Description

Balizador de parede ou tecto de design circular e inovador, que permite uma projecção de luz vincada, mas suave. Construído em alumínio, e com acabamento em branco mate. Ideal para espaços empresariais e hotelaria.

Wall or ceiling beacon with a circular and innovative design, which allows a soft light line projection. Constructed of aluminum, and finished in matt white. Ideal for business and hotel spaces.

Luminaire murale ou plafonnier au design en forme d'ellipse et innovant, qui permet une projection de faisceau lumineux agréable. Construit en aluminium et finition blanc mat. Idéal pour les espaces tertiaire et hôtellerie.

Difusor • Diffuser • Diffuseur

Acrílico Fosco
Frosted Acrylic
Acrylique Opaline

Lâmpadas • Lamps • Lampes



A (mm)	B (mm)	Lumens
60	20	90

Acabamento • Finishing • Finition

Branco Mate
Matt White
Blanc Mat

CÔA

Descrição • Description • Description

Luminária em alumínio torneado com acabamento escovado.

Aluminium light fixture with brushed finish.

Luminaire en aluminium avec finition brossée.

Difusor • Difuser • Diffuseur

Vidro Temperado Transparente

Clear Tempered Glass

Verre Trempé Clair

Lâmpadas • Lamps • Lampes

3x LED 1W - 6000K

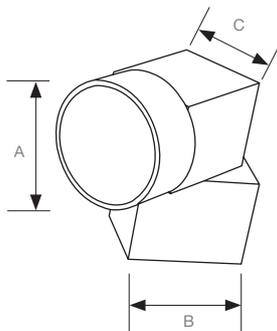

	A (mm)	B (mm)	C (mm)
Côa	55	54	42



Acabamento • Finishing • Finition

Alumínio Escovado
Brushed Aluminum
Aluminium Brossé

reserva

A informação referente aos nossos produtos pode ser modificada com o objectivo de melhorar as características ou desenhos. A Begolux reserva-se o direito de anular ou modificar qualquer modelo sem aviso prévio e sem que seja motivo de reclamações. Estas modificações serão actualizadas no nosso site.

As características, potências, eficiências luminosas que aparecem neste catálogo, estão sujeitas a variações e melhorias, baseadas na velocidade da evolução tecnológica a que estes produtos estão sujeitos assim como são os vigentes na data de impressão do catálogo salvo erro tipográfico.

The information regarding our products can be modified in order to improve the characteristics or designs.

Begolux reserves the right to cancel or modify any model without prior notice and without cause for any complaints. These modifications will be updated on our website.

The characteristics, powers and luminous efficiencies that appear in this catalog are ruling at the date of printing of the catalog except for a typographical error, and they are also subject to variations and improvements, based on the speed of the technological evolution to which these products are subject.

Les informations concernant nos produits peuvent être modifiées afin d'améliorer les caractéristiques ou les conceptions.

Begolux se réserve le droit d'annuler ou de modifier tout modèle sans préavis et sans préjudice. Ces modifications seront mises à jour sur notre site.

Les caractéristiques, les pouvoirs et les gains d'efficacité lumineux qui apparaissent dans ce catalogue sont en vigueur à la date d'impression du catalogue à l'exception d'une erreur typographique et sont également soumis à des variations et à des améliorations, en fonction de la vitesse de l'évolution technologique à laquelle ces produits sont sujet.

aviso
disclaimer

sauvegarde

BEGOLUX
iluminação

Rua Vasco da Gama, 65
4510-682 Fânzeres
T. (+351) 229 734 355
E. geral@begolux.com
W. www.begolux.com

COMPETE
2020

PORTUGAL
2020



UNIÃO EUROPEIA

Fundo Europeu
de Desenvolvimento Regional