



# PRODUCTS **AND** ACCESSORIES



## CONTENT – INHALT

### DOLLIES

- 4 MAGNUM SYSTEM DOLLY
- 14 ALPHA DOLLY
- 16 ARCO DOLLY
- 18 SPRINTER LIGHT DOLLY
- 20 ROCKER DOLLY
- 22 SCOOTER DOLLY
- 24 CRANE DOLLY CD 5
- 25 CRANE DOLLY CD 7



### REMOTE HEAD

- 26 REMOTE HEAD P15



### CRANES

- 28 MOVIE JIB
- 30 JIB 100
- 31 MASTER JIB
- 32 MT400 CRANE SYSTEM



### TRACK SYSTEMS

- 36 MASTER TRACK SYSTEM
- 37 MOVIE TRACK SYSTEM

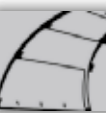

### GENERAL ACCESSORIES

- 38 GENERAL ACCESSORIES
- 42 KOFFER / CASES



## Welcome to MovieTech

Our vision is to help our customers achieve the moving shot with any type of camera in any situation with constantly updated film equipment. This is a challenge that we are pleased to pursue and that we can only master with constant feedback from our customers.

We wish you great pleasure using our products.

*Unsere Vision ist es, unseren Kunden zu helfen, alle Kameratypen in jeder Situation bewegen zu können. Dies ist für uns eine Herausforderung, der wir uns gerne stellen und die wir nur durch einen ständigen Dialog mit unseren Kunden meistern können.*

*Wir wünschen Ihnen viel Freude mit unseren Produkten und freuen uns über Ihre Wünsche und Anregungen.*

**MovieTech AG**  
 Martin-Kollar-Str. 9  
 81829 München  
 Germany  
 Tel: +49 (0)89-43 68 91 3  
 Fax: +49 (0)89-43 68 91 55  
 E-Mail: info@movietech.de

**MovieTech S.r.l.**  
 Viale Edison 318  
 20099 Milano  
 Italia  
 +39 (0)2 22 47 00 43  
 +39 (0)2 24 41 01 63  
 E-Mail: k.shore@movietech.de



[www.movietech.de](http://www.movietech.de)

Technical specifications and scope of delivery are subject to change without notice. For further informations please feel free to contact us.

*Abbildungen entsprechen nicht immer dem Lieferumfang.  
 Für weitere Informationen steht Ihnen unser Vertrieb gerne zur Verfügung.*



## The Magnum Dolly System

...wächst mit seinen Aufgaben!  
...grows with its tasks!

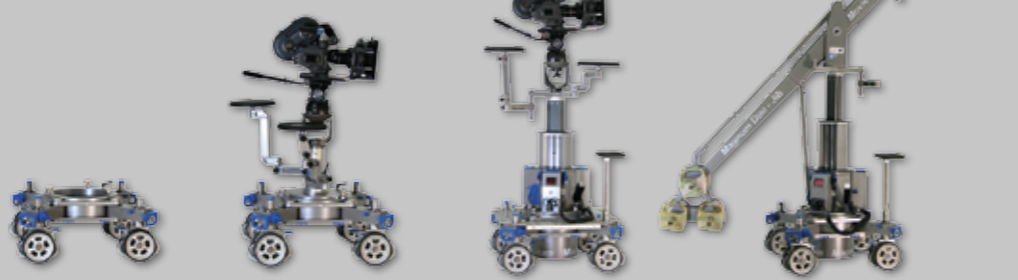

Kernstück des Magnum Dolly ist die Basisplattform „Leggero“, die sich wahlweise mittels Studio- oder Schienenräder bewegen lässt.

Mit Hilfe der Basisplatte lassen sich dann die verschiedensten Aufbauten realisieren: Ein simpler Aufbau mittels Säulenverlängerung oder Bazooka...

...oder die High-Tech-Variante mit programmierbarer, elektromechanischer Hubsäule der neuesten Generation.

Darauf lassen sich wiederum verschiedene Rigs montieren, um für Kamera und Kameramann die idealen Positionen zu schaffen.

The heart of the Magnum Dolly is the basic platform „Leggero“ which can be moved either by rail or studio wheels.

Mounting the base plate permits to achieve various dolly setups: A simple setup with a column extension or riser...

...or the high-tech setup with programmable, electro-mechanical column of the latest generation.

Various rigs may now be mounted in order to find the optimal position for camera and camera man.



**Magnum Art.Nr. | Item No. 2000-0SET**  
Magnum Dolly System inkl. Leggero Basic Dolly - Modulares Dollsystem mit elektromechanischer Säule  
Magnum Dolly System incl. Leggero Basic Dolly - Modular dolly system with electromechanical column

Bestehend aus:

- Leggero Basis-Dolly (Art. Nr. 1000-300)
- Magnum Dolly Säule 48 Volt (Art. Nr. 2000-0)
- 2 Sitze (Art. Nr. 2058-0)
- Handregleradapter für Lenker (Art. Nr. 1040)
- 3 Kappen für Steuerungsanschlüsse
- Betriebsanleitung

Consisting of:

- Leggero Basic Dolly (Item No.1000-300)
- Magnum Dolly 48V column (Item No. 2000-0)
- 2 seats (Item No. 2058-0)
- hand control holder for steering rod (Item No.1040)
- 3 adapter covers for control unit
- user manual

### MovieTech Magnum Dolly

Der einzigartige Systemdolly – unvergleichlich durch seine enorme Flexibilität. Das umfangreiche Zubehörprogramm lässt sich äußerst variabel kombinieren. Design und Qualitätsstandards sorgen maßgeblich für die hohe Zuverlässigkeit  
„made by MovieTech“.

### MovieTech Magnum Dolly

The unique Dolly-system - incomparable for its enormous flexibility. The extensive range of accessories guarantees combinations in various ways. High design and quality standards assure the high reliability  
„made by MovieTech“.



2004-0SET

besteht aus  
Art.Nr. 2004-0 und 2002-0  
built up of  
Item No. 2004-0 and 2002-0



2019-0

2003-0

2000-0SET

2014-0

2015-0

2190-0000A

2020-0

Teams in aller Welt vertrauen auf das bewährte Magnum Dolly System

Teams in the whole world trust in the proven Magnum Dolly System



### Zubehör / Accessories

2004-0SET	24V Ladestation komplett für 2 Akkus	24 Volt charging station complete for 2 batteries
2004-0	24V Ladeadapterplatte für 2 Akkus	Charger adapter plate
2002-0	Magnum Universal Ladegerät 24/48V	Magnum mains/charger unit 24/48 volt
2003-0	Akku 24V mit Ladezustandsanzeige	Magnum 24 volt battery with charge level indicator
2014-0	Handregler-Prüfgerät	Test device for hand control unit control
2015-0	Prüfgerät für Akku 24V	Tester for 24V batteries
2019-0	Netzteil 230V	Power Supply Box 230 V
2020-0	Kurzschlussstecker für 24V-Betrieb	Bridge plug for 24V operation
2190-0000A	El. Steuerung 24/48V für MAGNUM (o. Gehäuse)	Electronic kit 24/48 V for Magnum Column (without case)





1000-300

**Der Leggero plus Basisplatte ist die einfachste und kompakteste Anwendungsform des Magnum.**

- 360° drehbar mit integr. Feststellbremse
- besonders geräuscharmes und sanft laufendes Drehlager
- inklusive Eurozapfen
- herausnehmbar
- für besonders tiefe Aufnahmeposition

**The Leggero plus base plate is a very simple and compact version of the Magnum**

- 360° rotatable with integrated brake
- very silent and smooth bearing
- inclusive euro mount
- removeable
- for extrem low shot positions



1003-Set



1002-0



1006-0



1020-0

**Magnum Base-Dolly Art.Nr. | Item No. 1000-300**

**Basis-Dolly - Basisdolly für MagnumDolly-System mit integr. 360° Kugel-Drehlager**  
**Base dolly for Magnum Dolly System with integrated rotatable 360° bearing**

Bestehend aus:

- Basis Dolly
- Lenker standard (Art. Nr. 1010-0)
- schnellwechselbare Kombiräder (Studio-/Schiennenrad) mit Crab/Steer/Sperr/Frei- Funktion (Art.Nr. 1200-250)

Consisting of:

- Base dolly
- Steering rod standard (Item No. 1010-0)
- quick change combi-wheels (studio/ track wheels) with crab/steer/lock/free rotate function (Item No. 1200-250)

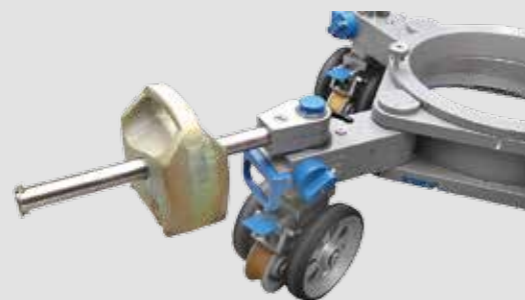

2084-0

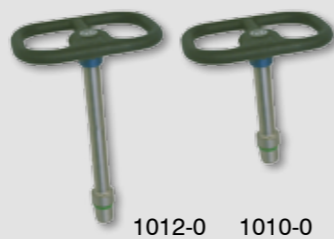

1012-0 1010-0



2099-0

**Zubehör / Accessories**

1002-0	Basis-Platte mit Euroadapter	Base plate with Euro Adapter for Basic-Dolly
1003 Set	Basisplatte mit Drehkreuz	Base plate with turnstile mount
1006-0	Drehkreuz (Basisplatte 1002-0)	Turnstile mount for base plate 1002-0
1010-0	Lenker kurz	Steering rod short
1012-0	Lenker standard	Steering rod standard
1020-0	Ausleger für Lenker	Magnum steer-out extension
2084-0	Gegengewichtarm für Magnum Dolly	Counter balance rod for Magnum Dolly
2099-0	Schiebstanze für Magnum Dolly	Push bar for Magnum Dolly

**Magnum Dolly column Art.Nr. | Item No. 2000-0**

**Magnum Dolly Säule 48 Volt - elektromechanische Hubsäule für Magnum Dolly System**  
**Magnum Dolly 48V column - Electromechanical column for Magnum Dolly System**

Mit integriertem Drehkreuz.

Inkl.:

- 48V-Motor mit Mikroprozessorsteuerung mit Selbstdiagnose, vierstufiger Rampe für DuoJib- oder Standardbetrieb, 4 separat speicherbare Programmabläufe. Integriertes digitales Display für Höhe, Position, Kanal, Rampe, Fehlercodes, integrierte Notfallsicherung.
- 2 Akkus 24V mit Ladezustandsanzeige (Art. Nr. 2003-0)
- Handregler mit Kabel, Haupt-Ein-/Aus-Schalter, Geschwindigkeitsschalter, Funktionsanzeige (Art. 2008-0000A)
- Sitzarm (Art. 2070-300)
- Betriebsanleitung

With integrated turnstile mount and brake.

Incl.:

- 48V-motor with microprocessor control with self diagnostics and display, 4 stage ramp selector for Duo Jib or standard use, 4 separate programming channels. Integrated digital display for height, program position, program channel, selected ramp, error display.
- Integrated emergency back-up in column,
- 2 batteries 24V with charge level indicator)
- hand control unit with cable, mains on/off switch, stage speed selector, function indicator (Item No. 2008-0000A)
- seat support (Item No. 2070-300)
- manual.



2000-0

**„Das Herz der Bewegung“**

...ist die herausnehmbare, elektromechanische Säule. In Sekunden montiert und einsatzbereit. Das integrierte Drehkreuz ermöglicht eine 360°-Rotation von bis zu zwei Personen.

**„The heart of the movement“**

...is the removable electromechanical column. Mounted and ready for use within seconds. The integrated turnstyle enables a 360° rotation for up to two persons.



1040-0

Der Schwenkarmadapter ermöglicht die Montage des Handreglers bis zu einem Rohrdurchmesser von 19 - 25mm.

The swivel arm adapter makes the mounting of the hand control possible with pipe diameters of 19 - 25 mm (3/4 - 1 inch.)



2013-0

In der Höhe und Position verstellbare Aufnahme für Handregler, für die ideale Positionierung der Bedienungseinheit.

Adjustable hand control holder always provides perfect position for the control unit.

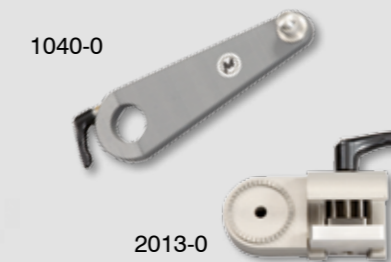

1040-0

2013-0

**Zubehör / Accessories**

2013-0	Schwenkarmadapter für Handregler Magnum	Pan bar adapter for Magnum Remote Control
1040-0	Handregleradapter für Lenker	Hand control holder
2089-01	Magnum Funkhandregler	Magnum radio hand control

**Ersatzteile / Spare parts**

2003-0	Akku 24V mit Ladezustandsanzeige, s. Seite 5	Magnum 24 volt battery, see page 5
M3269	Handreglerkabel	Cable for hand control
2008-0000A	Handregler mit Programmtastatur und Kabel	Hand control unit with programme keyboard and cable

Funk-Handregler  
Radio controlled  
hand control



2089-01



2008-000A



M3269

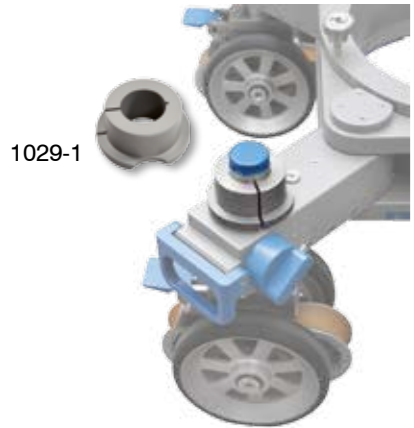

1029-1



1028-0



1200-253Set



1210-0SET

1212-0SET

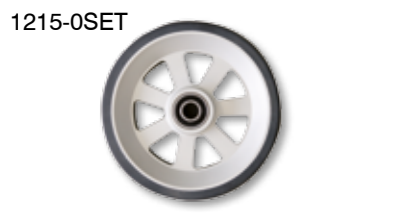

1215-0SET

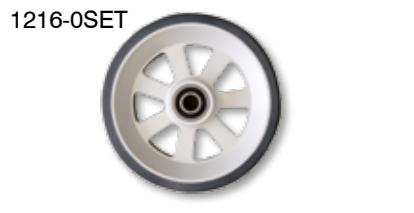

1216-0SET

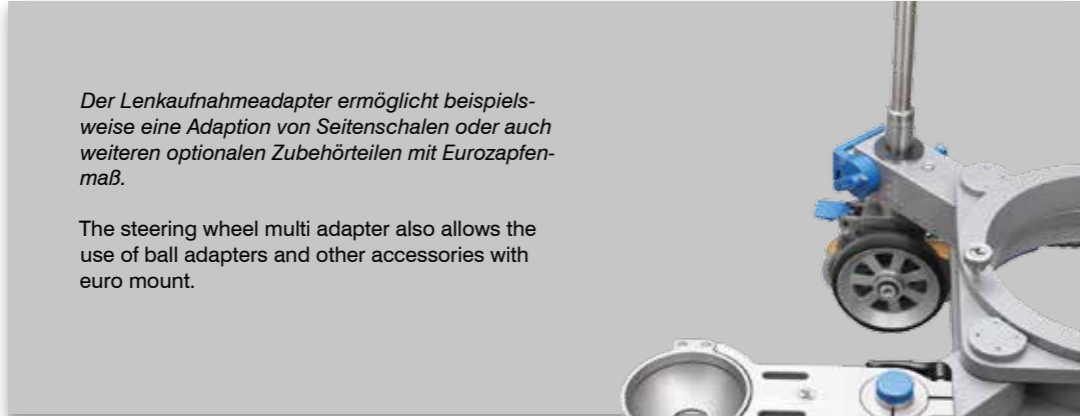

Der Lenkaufnahmeadapter ermöglicht beispielsweise eine Adaption von Seitenschalen oder auch weiteren optionalen Zubehörteilen mit Eurozapfenmaß.

The steering wheel multi adapter also allows the use of ball adapters and other accessories with euro mount.



2057-1

1028-0

In der Sitzposition verstellbarer Sitzaufnahmeadapter für den Assistenten. Mit Verbindungsbolzen (2057-1) können Varianten der Sitzarme „kombiniert“ oder „senkrecht“ montiert werden.

Adjustable seat adapter for the assistant. With connection bolts (2057-1) all types of seat-arms can be combined to suit the rider / user.



2025-0SET

Zubehör / Accessories

1028-0	Assistent Sitzaufnahmeadapter	Seat or platform mount
1029-1	Multi-Adapter (für Lenkausleger)	Multi adapter (for steering rod)
1200-253Set	Schienenrad inkl. Achse und Lager	trackwheel incl. axle and bearing
1210-0Set	Satz Lufräder (210 x 65 mm) (8x)	Set of pneumatic wheels (8 pcs)
1212-0Set	Schlüssel für Lufräder	Key for pneumatic wheels
1215-0Set	Satz Studioräder weich (40 Shore) (8x)	Set of studio wheels, soft (8pcs) 40 shore
1216-0Set	Satz Studioräder hart (80 Shore) (8x)	Set of studio wheels, standard (8 pcs) 80 shore
2025-0Set	Tragestangenset	Set of carrying bars
2057-1	Verbindungsbolzen	Connection bolt



2118-100

Eine Auswahl an verschiedenen Trittplattformen sorgt durch die rutschsichere Raupenoberfläche oder einen Antirutschbelag für einen sicheren Stand.

A choice of different step platforms with non-slip (caterpillar) surface always provides a safe stand.



1036-01

1045-0

Die Ringplattform ermöglicht einen größeren Komfort und schnellere Drehung des Kameramanns um die Mittelsäule.

The ring platform permits the operator to turn easier and faster around the column.

Die Tiefplattform lässt sich in der Höhe variabel verstellen.

The low platform is height adjustable.

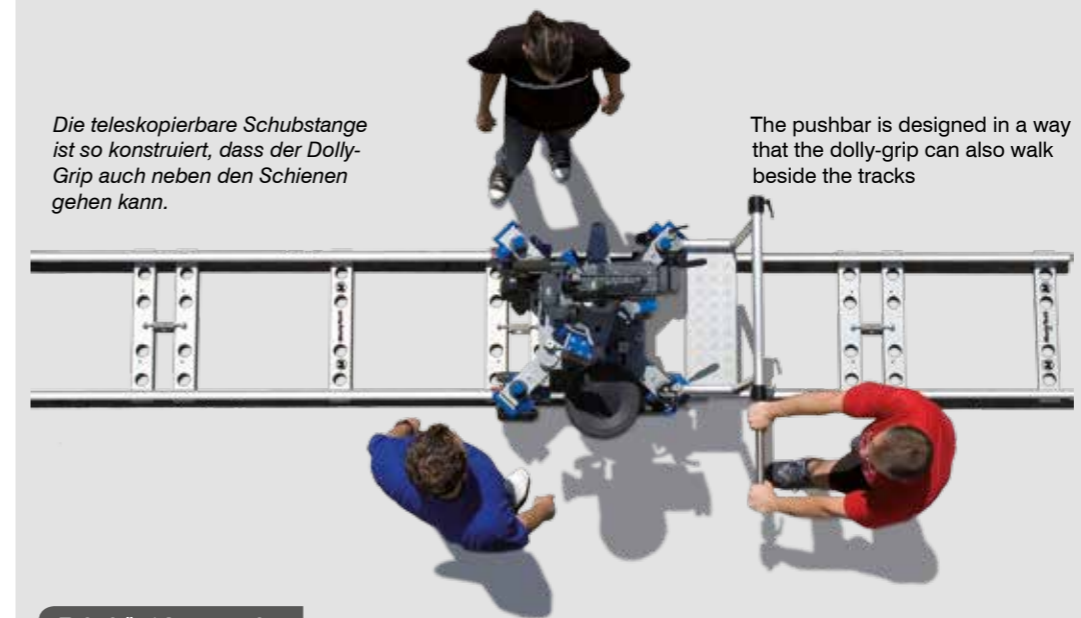

Die teleskopierbare Schubstange ist so konstruiert, dass der Dolly-Grip auch neben den Schienen gehen kann.

The pushbar is designed in a way that the dolly-grip can also walk beside the tracks

Zubehör / Accessories

1036-01	Magnum System-Plattform-Set (4Teile)	Magnum system platform set (4 pcs.)
1045-0	Tiefplattform für Magnum Dolly	Low platform for Magnum Dolly
2118-100	Ringplattform inkl. Deckel	Ring platform incl. cover
M2005	Staubschutzhaube für Magnum Säule	Dust cover for Magnum Column
M2180	Regenschutzhaube für Magnum Dolly	Rain / dust cover Magnum Dolly
2075	Magnum-Werkzeug im Koffer (o. Abb.)	Magnum tool kit in hard case (not illustrated)



2118-100



1045-0

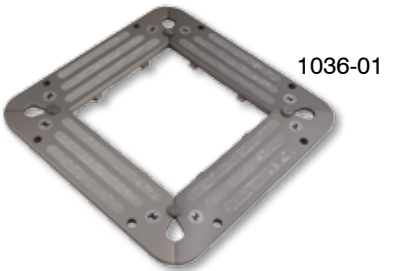

1036-01



M2005

...schützt bei Wind und Wetter.

...protects against wind and rain



M2180

**Low rig-set** Art.Nr. | Item No. 2087-0SET

**Systemausleger-Set - als Mini-Tiefausleger, Seiten- oder Hochausleger einsetzbar**  
**System low rig-set – useable as mini-low rig, side rig or high rig**

Bestehend aus:

- 3 hartcoatierte Aluminium-Rohre 300/400/765 mm
- 1 Verbindungsrohr
- 1 Ausleger 540mm mit Doppel-Euromountadapter
- 1 Ausleger 455mm mit Doppel-Euromountadapter
- 2 Endstücke
- Rollkoffer
- Euroadapterabschlussstück

Consisting of:

- 3 hard coated aluminum tubes 300/400/765 mm
- 1 connecting tube
- 1 outrigger 540mm with double euro mount adapter
- 1 outrigger 455mm with double euro mount adapter
- 2 end capes
- roll case
- end piece with euro mount



2087-0

2087-0SET



**Zubehör / Accessories**

2110	Gegengewicht 16 kg	Counterweight 16 kg / 33 lbs
2111	Gegengewicht 10 kg	Counterweight 10 kg / 22 lbs
2112	Gegengewicht 5 kg	Counterweight 5 kg / 11 lbs

sowie alle Universal-MovieTech-Zubehörteile

as well as all universal MovieTech parts

**Low rig** Art.Nr. | Item No. 2080-0

**Tief- und Seitenausleger**  
**Low and side rig**

Bestehend aus:

- 3 Gusssegmenten mit Euromount-aufnahme oben, Eurozapfen unten

Consisting of:

- 3 segments with euro mount adapter on top, euro mount at the bottom

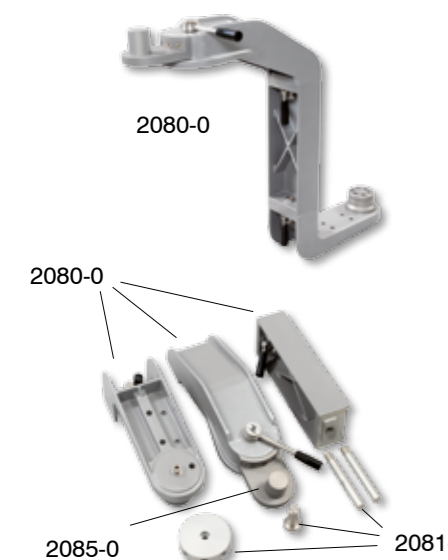

2080-0

2080-0

2084-0

2080-0

2081-0

**Zubehör / Accessories**

2110	Gegengewicht 16 kg	Counterweight 16 kg / 33 lbs
2111	Gegengewicht 10 kg	Counterweight 10 kg / 22 lbs
2112	Gegengewicht 5 kg	Counterweight 5 kg / 11 lbs
2085-0	Aufnahme für Gegengewichtsarm	Connector for counterbalance rod
2081-0	Fußstütze / Sitzarmbolzen	Feet and seat support kit

sowie alle Universal-MovieTech-Zubehörteile

as well as all universal MovieTech parts

**MovieJib** Art.Nr. | Item No. 2114-01

**MovieJib - Jib-Arm mit variabler Auszugslänge und integrierter vertikaler und horizontaler Bremse.**  
**Max Zuladung 40 kg. Hubhöhe max. 2,79 m. Eigengewicht 41 kg.**

**MovieJib – Jib with variable extension length and integrated brales (vertical and horizontal).**  
**Max. payload 40kg. Lift height max. 2,79m. Weight 41kg.**

Bestehend aus:

- 8-Stufen Teleskopsystem (Distanz in den Stufen 65mm)
- Kurbelantrieb für stufenlose Gegengewichtsverstellung
- Zwei Bremsen (horizontal/vertikal)
- Gegengewichtsstange / Länge 725 mm / Durchmesser 30 mm (Art. Nr. 2114-400)
- Handgriffe mit Sicherheitsfunktion
- Transporttasche

Consisting of:

- 8 steps telescopic system (distance step to step 65mm)
- Crank lever for weight counterbalance
- Two brakes (horizontal/vertical)
- Tripod Bullstand 120
- Counterweight rod / length 725 mm / diameter 30 mm (Item No. 2114-400)
- Handle with safety function
- Softbag



**Weitere Informationen auf Seite 24**  
**More information on page 24**

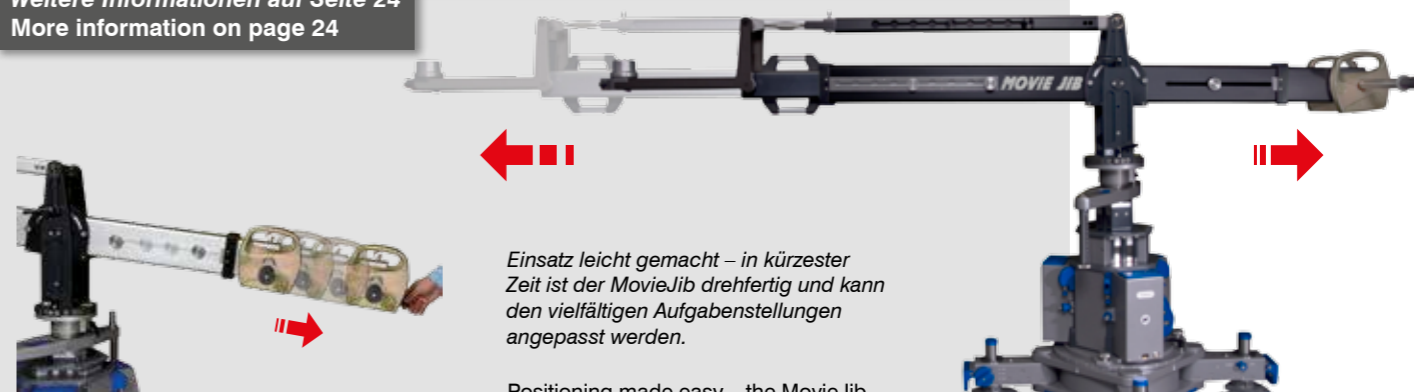

*Einsatz leicht gemacht – in kürzester Zeit ist der MovieJib drehfertig und kann den vielfältigen Aufgabenstellungen angepasst werden.*

*Positioning made easy – the MovieJib is ready for filming shortly and can be adapted to a variety of tasks.*

*auch montierbar auf... also mountable on...*

**Abmessungen / Dimensions**

Länge Zentralgelenk bis Krankopf / Front arm length - center to top	min. 1,65m	max. 2,15m
Länge Zentralgelenk bis Gewichtsstange / Rear part length from center	min. 0,75m	max. 1,08m
Höhe max. mit Stativhöhe (1,27m) / Max height with tripod height (1.27m)	2,80 m	

**Gewichte / Weights**

Max. Gegengewicht / Max counterweight	72 kg (4 x 16 + 2 x 5 kg)
Max. Traglast (Krankopf ganz ausgefahren) / Max. load (max. extended)	30 kg
Max. Traglast (Krankopf ganz eingefahren) / Max. load (min. extended)	40 kg

**Zubehör / Accessories**

2110	Gegengewicht 16 kg (s. Seite 10)	Counterweight 16 kg / 33 lbs (s. page 10)
2111	Gegengewicht 10 kg (s. Seite 10)	Counterweight 10 kg / 22 lbs (s. page 10)
2112	Gegengewicht 5 kg (s. Seite 10)	Counterweight 5 kg / 11 lbs (s. page 10)
2031-0	Kugelschale 150 mm (s. Seite 38)	Ball adapter 150mm (s. page 38)
2041-10	Mitchell Basisplatte (s. Seite 39)	Mitchell base plate (s. page 39)
2087-25	Euroadapter doppelt (s. Seite 38)	Double euro-mount (s. page 38)
G2114-50	Adapter Euromount für Magnum (s.S. 29)	Euromount adapter for Magnum (s. page 29)
2192	Koffer für Movie Jib	Transport case for MovieJib
8321-03	Stativ Bullstand 120	Tripod Bullstand 120
8315-30	Monitorhalter für Movie Jib (s. Seite 29)	Display support for MovieJib (s. page 29)
7570-0SET	Kran-Dolly CD 7 mit Lufträdern inkl. Säule und Säulenadapter	Crane dolly CD 7 with pneumatic wheels incl. column and column adapter

sowie alle Universal-MovieTech-Zubehörteile

as well as all universal MovieTech parts



...Crane Dolly CD7



...Bullstand



2192

2100-0

**MiniJib** Art.Nr. | Item No. 2100-0

**MiniJib**

Bestehend aus:

- Kranstütze mit integrierter Bremse
- Alu-Vierkant-Hauptsegment
- Teleskopierbares Endsegment
- Parallelogrammstange mit integrierter Vertikalbremse
- Eurozapfen am Jibende
- Gewichtsstange
- Handgriff seitlich zum Führen

Consisting of:

- Crane support with integrated brake
- Aluminum main segment
- Telescopic end segment
- Parallelogram rod with integrated vertical brake
- Euro mount at the jib end
- Counterweight rod
- Handle bar for steering



2106-0

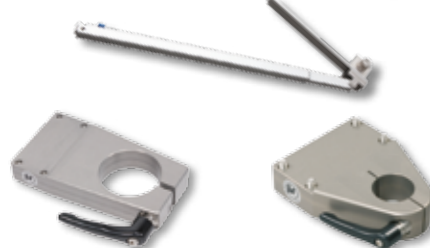

2117-0



2101-0



2090-0

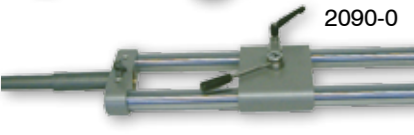

2090-0



2091



2095-1000

**Zubehör / Accessories**

2110	Gegengewicht 16 kg (s. Seite 10)	Counterweight 16 kg / 33 lbs (s. page 10)
2111	Gegengewicht 10 kg (s. Seite 10)	Counterweight 10 kg / 22 lbs (s. page 10)
2112	Gegengewicht 5 kg (s. Seite 10)	Counterweight 5 kg / 11 lbs (s. page 10)
2101-0	Seitenausleger MiniJib	Off-Set rig for MiniJib
2102-0	Euroadapter Platte MiniJib	Euro adapter mount for MiniJib
2103-0	Tiefausleger-Adapter für MiniJib	Low Rig Adapter for MiniJib
2117-0	Systemtiefausleger Adapter für MiniJib	System Low Rig Adapter for MiniJib
2106-0	MiniJib-Armverbindungsstange	MiniJib connector rod to Magnum Column
2169	Transportkoffer für MiniJib (o.Abb.)	Transport case for MiniJib Arm (not illustrated)

sowie alle Universal-MovieTech-Zubehörteile

as well as all universal MovieTech parts

**U-Bangi** Art.Nr. | Item No. 2090-0

**U-Bangi Komfort-Kameraausleger. Länge 1100 mm**  
**U-Bangi Camera rig. Length 1100 mm**

Bestehend aus:

- Hauptsegment
- Gegengewichtsarm

Consisting of:

- Main segment
- Counterweight rod

**Zubehör / Accessories**

2091-1000	Kombiadapter 80 für U-Bangi	Combi adapter 80 for U-Bangi
2091	Drehgelenk mit Feststellbremse	Rotatable Adapter with brake

sowie alle Universal-MovieTech-Zubehörteile

as well as all universal MovieTech parts

**DuoJib** Art.Nr. | Item No. 2120-0

**DuoJib – 360° schwenkbar für 2 Personen**  
**DuoJib – 360° rotatable for 2 persons**

Bestehend aus:

- Dehkreuz/ Plattform (Art. Nr. 2120-150)
- Hoch- und Tiefausleger (Art. Nr. 2120-200)
- Gewichtsstange (Art. Nr. 2120-90)
- Parallelogrammstange (Art. Nr. 2120-300)
- Kranstütze
- Endsegment mit Gegengewichtsstange
- Verbindungsstange
- Ausleger

Consisting of:

- turnstile/ platform (Item No. 2120-150)
- high and low rig (Item. No. 2120-200)
- counter weight rod (Item No. 2120-90)
- parallelogram rod (Item No. 2120-90)
- crane support
- end segment with counterweight rod
- connection rod
- arm



Durch die gleitende 360° Rotation des Magnum und die hohe Präzision seiner Säulenmechanik sind besonders gleichmäßige, weiche Bewegungsabläufe mit dem DuoJib garantiert. Das geringe Transportvolumen und die kurzen Aufbauzeiten machen den DuoJib besonders bedienungsfreundlich.

Thanks to the 360° ball bearings and the precision of the Magnum column, perfectly smooth movements with the DuoJib are guaranteed. It is extremely portable and easy to set-up which makes it particularly user - friendly.

**Zubehör / Accessories**

2110	Gegengewicht 16 kg (s. Seite 10)	Counterweight 16 kg / 33 lbs (s. page 10)
2111	Gegengewicht 10 kg (s. Seite 10)	Counterweight 10 kg / 22 lbs (s. page 10)
2112	Gegengewicht 5 kg (s. Seite 10)	Counterweight 5 kg / 11 lbs (s. page 10)
2167	Transportkoffer für DuoJib komplett	Transport case for DuoJib complete
2130-0	Säulenverlängerung 10cm	Riser 10 cm / 4"
2131-0	Säulenverlängerung 20 cm	Riser 20 cm / 8"
2132-0	Säulenverlängerung 30 cm	Riser 30 cm / 12"
2133-0	Säulenverlängerung 40 cm	Riser 40 cm / 16"
2134-0	Säulenverlängerung 50 cm	Riser 50 cm / 20"
2135-0	Säulenverlängerung verstellbar 39-73 cm	Riser Adjustable 39-73 cm
2056-00	Sitzarm senkrecht 30cm (s. Seite 38)	Seat arm vertical 30 cm/12" (s. page 38)
2031-0	Kugelschale (s. Seite 38)	Ball adapter (s. page 38)

sowie alle Universal-MovieTech-Zubehörteile

as well as all universal MovieTech parts

2120-0



Der Magnum DuoJib ist ein kraftvolles Werkzeug für die Umsetzung Ihrer kreativen Ideen. Max. Zuladung 250 kg / 550lbs. Die max. Höhe beträgt 272 cm / 8' 11" bei einem Arbeitsbereich von 165 cm / 5' 5", ideal für die häufigsten Aufgabenbereiche.

The Magnum DuoJib is a really powerful "creative tool". With 250 kg / 550 lbs max. payload (standard mode), 272 cm/ 8' 11" max height (euro adapter) and 165 cm/ 5' 5" lift range it is ideal for most tasks.



2134-0 2133-0 2132-0 2131-0 2130-0



2135-0



2167

(Koffer ohne Inhalt)  
(Case without equipment)

**Alpha Dolly** Art.Nr. | Item No. 2300-0SET

**Dolly-System mit elektromechanischer Säule, Antrieb über Li-Ion-Akkus**  
Dolly system with electromechanical column, powered by Li-Ion battery packs

bestehend aus:

- Basisdolly mit integriertem Drehlager, Lenker standard, Kombiräder Studio/ Schiene
- elektromechanische Säule
- Akku-Adapterplatte V-Mount oder Gold Mount/ AB
- Sitz rund
- Sitzarm senkrecht 30cm
- Kugelschale 150mm mit Adapterring 100 auf 50mm

consists of:

- Base dolly with integrated turnstile, standard steering rod, combi studio/ track wheels
- Electromechanical column
- Battery adapter plate V-Mount or Gold Mount/ AB
- Seat round
- Vertical seat arm 30cm
- Ball adapter 150mm with adapter ring 100 to 150mm



Tragkraft bis 100 kg  
payload up to 100 kg

Der Alpha Dolly ist ein **Hubsäulendolly mit Kameraakku-Antrieb**. Er ist **leicht, kompakt und flexibel**, zudem kann er mit **niedriger Anfangshöhe (710mm)** und **neuem, schlanken Design** punkten. Die **elektromechanische Säule** des Alpha Dolly wird z.B. über drei Standard-Li-Ion-Akkus (14,4V/10-15A) gespeist, die entscheidende **Flexibilität und Unabhängigkeit in der Antriebsversorgung** bringen. Der Alpha Dolly ist **kompatibel mit zahlreichen Zubehörteilen** des Magnum- und Standard-Zubehörprogramms.

The Alpha Dolly is a **lightweight, compact and flexible** dolly system that scores with a **low starting position** of the column (710mm/ 27.95 inch) and a **new slender design**. It takes only e.g. three standard Li-Ion standard batteries (14,4V/10-15A) to operate the dolly which results in a **high flexibility and independence regarding the power supply**. The Alpha Dolly system is **compatible with many parts of the Magnum and standard accessory parts**.



Das neue Sitzkonzept orientiert sich an der bewährten Arbeitsweise des Scherendolly mit höhenverstellbarer Sitzposition an der Säule.

The new seating position at the column is equivalent to the familiar working method of the hydraulic lift arm dollies.



2300-8500

Der als Zubehör erhältliche teleskopierbare Sitzarm erlaubt dem Kameramann seine Sitzhöhe sekundenschnell anzupassen

The telescopic seat arm (available as accessory part) allows the operator to rapidly adjust his sitting height.

V-Mount oder Anton Bauer: Für den Antrieb der Säule können sämtliche Li-Ionen-Akkus eingesetzt werden.

V-Mount or Anton Bauer: To power the column, every Li-Ion battery can be used.



Der Alpha Dolly verfügt über ein eingebautes Drehlager, das 360°-Rotationen der Säule erlaubt.

The camera operator may rotate with the column thanks to the integrated 360° rotation system.



Mithilfe der System- und Anschlussplattformen lässt sich die Standfläche für den Kameramann flexibel erweitern

Via the system and connecting platforms, the operator's base can be flexibly adjusted

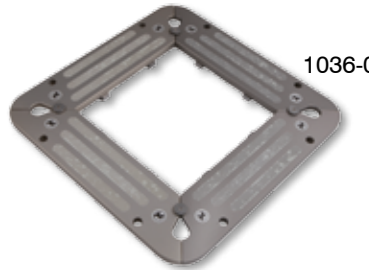

1036-01



2089-01

Funkhandregler  
Radio controlled hand control



- präzise und ruckfreie Säulenfahrten dank Mikroprozessorsteuerung
- Programmierbarkeit von Anfang- und Endpunkten, bis zu 30 Speicherpositionen und Motion Control-Funktion ermöglicht exakte Reproduktion der vertikalen Bewegungen
- versch. Geschwindigkeitsstufen und Rampeneinstellungen wählbar

- Precise and smooth column movements due to microprocessor control
- Allows to set low and high movement limit, store up to 30 points and motion control for an accurate reproduction of vertical movements
- Various speed and ramp settings selectable

**Zubehör / Accessories**

1036-01	System-Plattform-Set (4 Teile)	System platform set (4 pcs.)
xxxx	Anschlussplattformen	Connecting platforms
2300-8500	Teleskopierbarer Sitzarm	Telescopic seat arm
2089-01	Funkhandregler	Radio controlled hand control
Auf Anfrage/ on request	Li-Ion Akku	Lithium Ion battery

Weitere Zubehörteile S. 6-12 und 34-37  
More accessory parts on pages 6 to 12 and 38 to 41





1543-10



**Arco Dolly Art.Nr. | Item No. 1510-0**

**Arco Dolly System - Hydraulischer Scherendolly mit drei Getriebestufen (crab, round, conventional)**  
**Hydraulic camera dolly with 3 steering modes (crab, round, conventional)**

Mit Kombirädern (Studio-/Schienenrad), Lenker mit Getriebeumschalter, Ventil- und Pumpstange

Inkl.

- Tritt-Plattformsatz (links, rechts, vorne)
- Kaltgerätekabel
- 2 höhenverstellbare Sitze
- Schubstangen für ArcoDolly 2 Stk. (Art. Nr. 1537SET)
- Tiefausleger mit Schnellverschluss
- 90° Winkel standard (Art. Nr. 1535-0)
- Betriebsanleitung

Incl. combi-wheels (studio/ track wheels), steering rod with steering mode switch, pump-boom arm handle

Incl.

- set of platforms (left, right, front)
- power supply cable
- 2 adjustable seats
- set of push bars 2pcs. (Item No.1537SET)
- low rig with quick release
- 90° accessory plate (Item No. 1535-0)
- manual

**ARCO Dolly System**



Durch die große Auswahl an Zubehörteilen ist nahezu jede Kameraposition möglich  
 Thanks to the wide range of accessories, nearly every camera position is possible.



ARCO Dolly Art.Nr./Item No. 1510-0

**Zubehör / Accessories**

1510-50	Schlüssel-Radarmeinstellung (o. Abb.)	Key for wheel arm adjustment (not illustr.)
1510-60	Schlüssel-Radarmeinstellung (o. Abb.)	Key for wheel arm adjustment (not illustr.)
1525-0	Tragestagenset für Arco Dolly	Set of carry bars for Arco Dolly
1531-0	Tiefplattform vorne, klein	Low platform front, small, anodize
1532-0	Mitchell-Ausleger lang 24"	Long camera extension
1534-0	Kurze Kameraverlängerung	Short camera extension
1535-0	90° Winkel standard für Arco Dolly	90° accessory plate for Arco Dolly
1536-0	Akkualterung f. Arco Dolly	Battery holder
1541	Zubehörkoffer (o. Abb.)	Case for accessories (not illustrated)
1542	Koffer Arco Dolly (o. Abb.)	Case Arco Dolly (not illustrated)
1545-0	Verbindungsbolzen M24 für Arco (o. Abb.)	Bolt & Washer (not illustrated)
1548-0	Sitzarmknochen, lang geschliffen (o. Abb.)	Seat riser short (not illustrated)
1549-0	Sitzarmknochen, kurz geschliffen (o. Abb.)	Seat riser long (not illustrated)
1543-10	Seitliche Tiefplattform für Arco Dolly	Low side platform for Arco Dolly
1543-10SET	Seitliche Tiefplattform für Arco Dolly-Set (2x)	Side platform for ARCO dolly, set (2x)
1570-0	Luftschienenräder für Arco Dolly	Pneumatic and trackwheels for Arco Dolly
1570-0SET	Luft- und Schienenräder für Arco Dolly	Set of pneumatic and trackwheels for Arco Dolly
2024-0	4 Weg Mitchell Nivellierung	4 Way Leveller Mitchell
2027-0	4 Weg Mitchell Nivellierung von Euro auf Mitchell	4 Way Leveller Mitchell from euro to mitchell
2155-0	Säulenverlängerung Rohr Mitchell 20cm	Riser tubetyp mitchell 20 cm
2156-0	Säulenverlängerung Rohr Mitchell 30cm	Riser tubetyp mitchell 30 cm
2157-0	Säulenverlängerung Rohr Mitchell 40cm	Riser tubetyp mitchell 40 cm
2158-0	Säulenverlängerung Rohr Mitchell 50cm	Riser tubetyp mitchell 50 cm
2026-01	Adapter von Mitchell auf Eurozapfen mit langem Bolzen (o. Abb.)	Adapter from Mitchell on euromount with long bolt (not illustrated)
2026-0	Adapter von Mitchell auf Eurozapfen mit kurzem Bolzen	Adapter from Mitchell on euromount with short bolt
1537-SET	Schubstangenset	Pushbar set

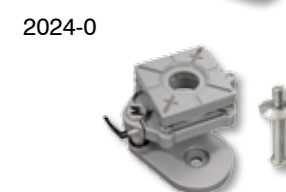
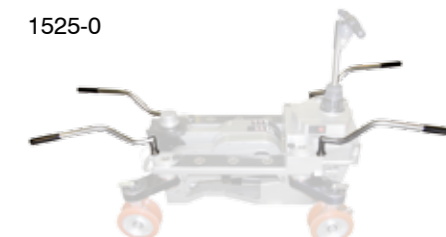
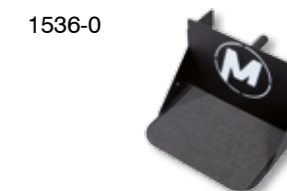

2900-0



2900-100

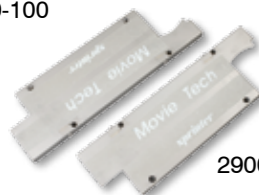

2900-120

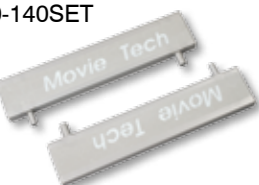

2900-140SET

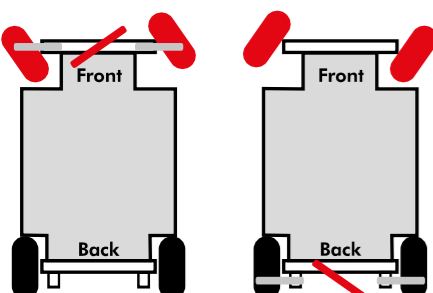

Steer it like a car

2900-200



2900-250



**Sprinter** Art.Nr. | Item No. 2900-0

**Sprinter Light Dolly – Leichtdollsystem**  
Lightweight dolly system

- Inkl.
- Standardplattform
  - 2 Trittbretter (links/rechts) (Art. Nr. 2900-100, 2900-120)
  - Lufttradsatz (Art. Nr. 2904-0SET)
  - Schienenradsatz Sprinter inkl. Koffer (Art. Nr. 2950-500)
  - Pushbar und Lenker (Art. Nr. 2900-200, 2900-250)
  - Drehkreuz (Art. Nr. 2901-100)
  - Betriebsanleitung

- Inkl.
- standard platform
  - 2 running boards (left/right) (Item No. 2900-100, 2900-120)
  - pneumatic wheels (Item No. 2904-0SET)
  - track wheel set in hard case (Item No. 2950-500)
  - push bar and steering rod (Item No. 2900-200, 2900-250)
  - turnstile (Item No. 2901-100)
  - manual

Der Sprinter Dolly  
...ein wirklicher Verwandlungskünstler

The Sprinter Light Dolly System  
...a real quick-change artist



Der Sprinter Dolly setzt durch zahlreiche überragende Ausstattungsdetails Maßstäbe in seiner Klasse.

The Sprinter Dolly with its standard features and expandability options sets benchmarks in its class.



...auch ein idealer Lastesel  
...also perfect for transportation

**Sprinter „Big Wheel“** Art.Nr. | Item No. 2900-02

**Sprinter Dolly „Big Wheel“ Set**

- Inkl.
- „Big Wheel“ Plattform
  - 1 Trittbrett (Art. Nr. 2907-0)
  - 4 Lufträder (Art. Nr. 2906-0)
  - Schienenradsatz Sprinter inkl. Koffer (Art. Nr. 2950-500)
  - Pushbar und Lenker (Art. Nr. 2900-200, 2900-250)
  - Drehkreuz (Art. Nr. 2901-100)
  - Betriebsanleitung

- Inkl.
- „Big Wheel“ platform
  - 1 running board (Item No. 2907-0)
  - pneumatic wheels 4 pcs. (Item No. 2906-0)
  - track wheel set in hard case (Item No. 2950-500)
  - pushbar and steering rod (Item No. 2900-200, 2900-250)
  - turnstile (Item No. 2901-100)
  - manual

Das Sprinter Big Wheel Set erhöht die Bodenfreiheit des Basismodells deutlich. Die große einteilige Plattform mit Antirutschbelag bietet ein Höchstmaß an Stabilität für Einsätze unter rauen Bedingungen.

The Sprinter Big Wheel set increases the ground clearance of the base model of the Sprinter considerably. The large, one-piece platform with non-slip surface provides maximum stability even under extreme conditions.



**Zubehör / Accessories**

2906-0	Luftreifen groß für Sprinter Dolly (1 Stück)	Big wheels for Sprinter Dolly (1 pcs.)
2904-0SET	Lufttradsatz für Sprinter (4 Stück) (o.Abb.)	Pneumatic wheels for Sprinter (4 pcs.) (n.i.)
2907-05	Plattform für Sprinter Dolly „Big Wheel“	Platform for Sprinter dolly „Big Wheel“
2920	Transportkoffer für Sprinter Dolly (o. Abb.)	Transport case for Sprinter Dolly (not illustr.)
2900-140SET	Trittbrettverbreiterung für Sprinter (1 Stück)	Footboard extension for Sprinter (1 pcs.)
2900-200	Schiebestange	Push bar
2900-250	Lenker	Steering rod
2950-500	Schienenradsatz	Set of track wheels
2961-01SET	Schienenradsatz für Kurve	Set of track wheel curve
2961-0	Adapter: Schienenrad MT 400 auf Sprinter Dolly (o. Abb.)	Adapter for trackwheel curve MT 400 on Sprinter Dolly (not illustrated)



2900-02



2901-100



2907-05



2906-0

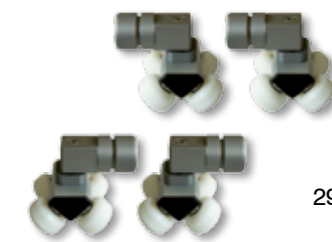

2950-500



2961-01SET

**Rocker Dolly** Art.Nr. | Item No. 2206-0

**Rocker Dolly – Tischdollsystem**  
**Rocker Dolly - table dolly system**

Mit 2 Tragegriffen, Eurozapfen klein, Klemme für Eurozapfen

With small euromount, euromount clamp, 2 carry handles

- Inkl.
- 2 Tischradsätze (Art. Nr. 2206-50)
  - Aufnahme für 4-Wege Nivellierkopf (Art. Nr. 2211-2)
  - Betriebsanleitung

- Incl.
- 2 sets of table wheels (Item No. 2206-0)
  - connector for 4 way leveler (Item No. 2211-2)
  - manual



Die wahre Größe des Rocker Dolly Systems wird besonders in ungewöhnlichen Situationen erlebbar. Das Leichtgewicht - mit minimalen Ausmaßen - lässt sich durch das umfassende Zubehör für vielseitige Einsätze modular erweitern.

The best time to appreciate the true versatility of the Rocker Dolly is in unusual situations! This lightweight dolly can be adapted to almost any situation by its extensive accessory range.

Ein weiterer Vorteil ist der Einsatz des Rocker Dolly als nivellierbare Bazooka Basis. Weitere Anwendungsmöglichkeiten ergeben sich durch die Nutzung von MovieTech Zubehör.

Another advantage of the Rocker Dolly is that it can be used as a levelling bazooka base. Even more applications are possible using MovieTech accessories.

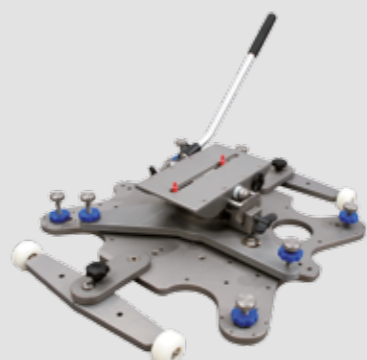

Die MovieTech Rocker Platte kann auf den vorgesehenen Aussparungen sicher montiert werden.

The MovieTech Rocker plate can easily be secured on the dolly.

Der optional erhältliche 4-Wege Nivellierkopf erweitert den Bereich der vielfältigen Einsatzmöglichkeiten.

The optionally available Mitchell 4-way leveler extends the range of possible operations for the Rocker Dolly.

Der Rocker Dolly ist unter anderem für das Filmen in sehr niedrigen Aufnahme-positionen konstruiert. Die verstellbare Lenkung ermöglicht zudem das Fahren von definierten Kurven auf eine einfache und präzise Weise.

The Rocker Dolly is made for filming where extremely low positions are necessary. Moreover, the adjustable steering makes the driving of defined curves possible in a simple and precise way.

Das Verbreiterungskit erweitert den Rocker Dolly Schieneneinsatzbereich auf die Standardspurweite von 62cm.

The extension kit for the track wheel set enables the use of the Rocker Dolly on the standard track width of 62cm / 24,5"



**Zubehör / Accessories**

2205-0	Rocker Platte	Rocker Plate
2206-100	Schubstange R.D.	Push bar for R.D.
2206-300SET	Verbreiterungssatz für R.D.	Extension kit for R.D. to 62cm gauge
220650	Transportkoffer für R.D.	Transport case for R.D.
220670	Schienenradsatz für R.D. inkl. Koffer	Track wheel set for R.D. incl. case
8530-0	Säulenverlängerung verstellbar / Broadcast	Riser adjustable, for broadcast
8531-0	Leichtkugelschale 100mm / Broadcast	Ball adapter light 100mm for broadcast
8532-1	Adapterring 100 mm auf 75 mm (o. Abb.)	Adapter 100 mm to 75 mm (not illustr.)
8511-01SET	Schienen gerade für Willi Go/R.D. (o. Abb.)	Tracks straight for Willi Go / R.D. (not ill.)
8521-300	Schienenkurve für Willi Go/R.D. 22,5°, kleiner Bogen (o. Abb.)	Track curve 22,5° for Willi Go / R.D. (not illustr.)

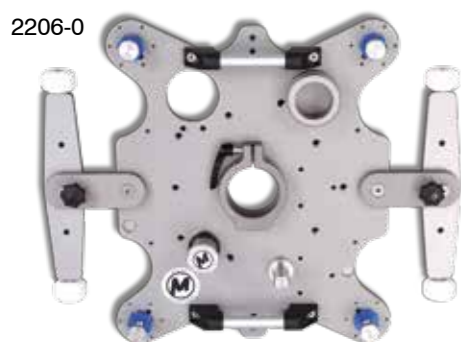

Verbreiterungssatz für Rocker Dolly auf 62cm/ 24,5" (einschl. Stativaufnahme)  
Extension kit for Rocker Dolly to 62cm/ 24,5" (incl. tripod support)





Tragkraft bis 35 kg  
payload up to 35 kg



Schnelle Nivellierung, kein Unterbau mit Holz und Keilen nötig.  
Rapid levelling - no wooden foundation



Keine Bazookas erforderlich, da die Höhe über Stativ reguliert wird.  
No bazookas necessary - height will be regulated by tripods



**Scooter Dolly** Art.Nr. | Item No. 2207-0SET

**Schienendolly-System**  
Track dolly system

bestehend aus:

- Scooter Dolly mit Klemmring 80mm
- Schienenverbinder (2x)
- Bodenplatten (2x)
- Transportkoffer Kunststoff mit Schaumform
- Bedienungsanleitung

consists of:

- Scooter Dolly with clamp ring 80mm
- Track connector (2x)
- Ground plate (2x)
- Case plastic with foaming mold
- Manual

Als kompakter Schienendolly für den Schmalspurbetrieb konzipiert, ist der Scooter Dolly dank seines verlängerbaren Schienensystems vielseitiger als ein normaler Slider-Dolly einsetzbar, gleichzeitig jedoch schneller als ein bemannter Kameradolly bereit. Mit dem Scooter kann das gesamte Kameraspektrum bewegt werden.

The Scooter Dolly is a quick and easy to setup compact camera dolly for use on narrow-gauge track, much more versatile than conventional slider systems thanks to the easily extensible track length. The Scooter Dolly can be used wherever a manned dolly system is superfluous. There are no camera weight limitations for the Scooter Dolly, the whole range of available camera types can be used. Its exceptional smoothness and quiet operation as well as durability make it a unique product of its kind.

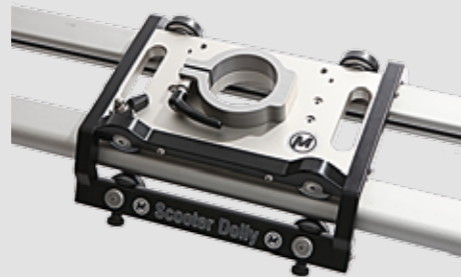

- Rollenanzugsdruck einstellbar
- Spezialrollen mit geräuscharmen Laufbelag - optimale Härteabstimmung gegen Abdrücke!
- Integrierte Bremse

- Adjustable wheel pressure
- Special noiseless wheels
- Integrated brake



Leichtbazooka Klemmring  
Light bazooka clamp ring 8530-2



Kugelschaleneinsatz 100 mm  
Bowl insert 100 mm 2032-1



Kugelschaleneinsatz 150 mm  
Bowl insert 150 mm 2031-3

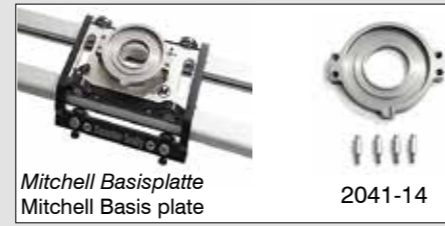

Mitchell Basisplatte  
Mitchell Basis plate 2041-14

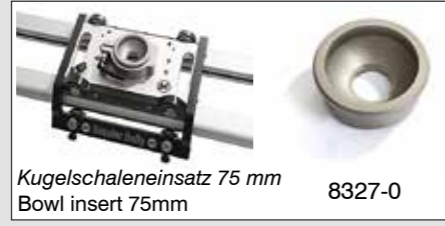

Kugelschaleneinsatz 75 mm  
Bowl insert 75mm 8327-0



Kugelschaleneinsatz 100 mm  
Bowl insert 100 mm 8328-0

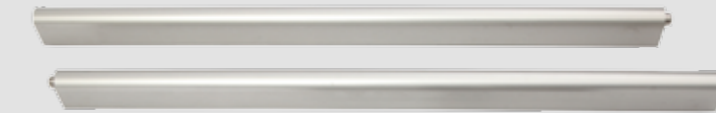

Schienen sind in 3 versch. Längen erhältlich (0,90m/ 1,60m/ 2,30m) und zu beliebigen Längen kombinierbar

Tracks are available in 3 different lengths (0,90m/ 1,60m/ 2,30m) and may be connected to any length

**Zubehör / Accessories**

8530-2	Leichtbazooka Klemmring	Light bazooka clamp ring
2032-1	Kugelschaleneinsatz 100mm	Bowl insert 100mm
8532-1	Einsatzring 100 mm auf 75 mm	Adapter ring 100 mm to 75 mm
2031-3	Kugelschaleneinsatz 150mm	Bowl insert 150mm
2041-14	Mitchell Basisplatte	Mitchell base plate
8327-0	Kugeladapter 75mm	Bowl adapter 75mm
8328-0	Kugeladapter 100mm	Bowl adapter 100mm
2207-30SET	Grundplatte Schienenverbinder	Ground plate track connector
2207-50	Euromountadapter/ Schienenverbinder	Euromount adapter/ track connector
2207-20	Bodennivellierplatte	Groundplate
2207-90	Kameragrundplatte/ Euromount	Camera base plate/ Euromount
xxxx	Monitorhalter Set 3/8" - 1/4" Adapter Kugelgelenke	Monitor holder set 3/8" - 1/4" adapter, ball joints
2500-2SET	Set MasterTrack Profile 0,90m	Set MasterTrack profile 0,90m
2501-1SET	Set MasterTrack Profile 1,60m	Set MasterTrack profile 1,60m
2502-1SET	Set MasterTrack Profile 2,30m	Set MasterTrack profile 2,30m
2207-8300	Tasche für Schienen 0,90m	Bag for tracks 0,90m
2207-8100	Tasche für Schienen 1,60m	Bag for tracks 1,60m
2207-8200	Tasche für Schienen 2,30m	Bag for tracks 2,30m
M5622	Schutzkappe rot für MasterTrack	Protection cap for MasterTrack
2594-0	Schutzschraube für Schienenendstück MasterTrack	Protection cap for track end section MasterTrack
2595-0		
2206-100	Schubstange	Push bar
2207-10	Endanschlag	Track end stop
8321-0	Kranstativ 132X	Tripod 132X



2207-30 2207-50



2207-20



2207-90



xxxx-xx



2207-10



M5622



2594-0  
2595-0



2206-100



7510-10

**CD5** Art.No. 7510-0

Krandolly CD 5 mit Lufträdern / Crane Dolly CD 5 with pneumatic wheels

**CD5** Art.No. 7510-01

Krandolly CD 5 mit Studiorädern / Crane Dolly CD 5 with track wheels

auch erhältlich als / also available as

Art. Nr. / Item No. 7510-0SET Krandolly CD 5 Set für Kran 100/120 mit Lufträdern und Lenker inkl. Säule und Säulenadapter für Kran 100/120

Crane Dolly Set CD 5 for crane 100/120 with pneumatic wheels and push bar incl. Column and adapter for crane 100/120

**CD5**

Nivellierstützen sorgen für optimale Stabilität  
Levelling legs provide high stability

Football World Cup 2002, 2006 and 2010

CD5 Crane Dolly mit ABC-Products Kran 120  
CD5 Crane Dolly with crane 120



**Zubehör / Accessories**

8410-0	Säule für Kran 100/120 auf CD5 / CD7	Column for crane 100/120 on dolly CD5 / CD7
7511-0	Schienenräder für CD5 / CD7	Track wheels for CD5 / CD7
7513-0	Plattform mit Drehkreuz	Platform with turnstile mount for CD5
8315-800	Adapter-Verlängerung (Kran 120 auf CD5) (o. Abb.)	Adapter-ext. (Crane 120 on CD5) (not illustrated)
7510-4000	Plattform für CD5	Platform for CD5
7520-0SET	Nivellierstützen für CD5 (4 Stck)	Levelling legs for CD5 (4pcs.)
2185	Transportkoffer für Schienenräder für CD5 / CD7 (o. Abb.)	Transport case for track wheels for CD5 / CD7 (not illustrated)

Mittels Drehkreuz kann der Krandolly zum Kameradolly aufgerüstet werden.

With the turnstile the crane dolly may be upgraded to a camera dolly.



7513-0

Krandolly CD 7 mit Lufträdern / Crane Dolly CD 7 with pneumatic wheels

**CD7** Art.No. 7570-0

Krandolly CD 7 mit Studiorädern / Crane Dolly CD 7 with track wheels

**CD7** Art.No. 7570-01

auch erhältlich als / also available as

Art. Nr. / Item No. 7570-0SET Krandolly CD 7 Set für Kran 100/120 mit Lufträdern und Lenker inkl. Säule und Säulenadapter für Kran 100/120

Crane Dolly Set CD 7 for crane 100/120 with pneumatic wheels and push bar incl. Column and adapter for crane 100/120

**CD7**

Die 3teilige Mittelsäule ist im Lieferumfang des 7530-0Sets enthalten  
The column is part of the 7530-0Set



7570-0

4-Radlenkung  
4-wheel steering

7531-0SET



Nivellierstützen  
levelling legs

Mittels Verbindungsbolzen lässt sich weiteres Zubehör montieren  
Via a connection bolt various accessory parts may be easily



Umschaltmechanik 2-Rad/4-Radlenkung  
mechanical switch 2/4 wheel steering mode



Tragegriffe ermöglichen einfachen Transport  
Easy transportation due to carrying handles

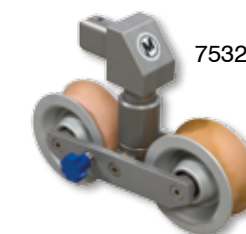

7532-0SET

**Zubehör / Accessories**

8410-0	Säule für Kran 100/ 120 auf CD5/ CD7	Column for crane 100/120 on dolly CD5/CD7
7531-0SET	Nivellierstützen für Krandolly CD7 (4 Stck)	Levelling legs for crane dolly CD7 (4pcs)
7532-0SET	Satz Schienenräder für Krandolly CD7	Set of track wheels for crane dolly CD7
2185	Transportkoffer für Schienenräder für CD5 / CD7 (o. Abb.)	Transport case for track wheels for CD5 / CD7 (not illustrated)



8410-0

2-Achsen-/Axis Version



3-Achsen-/Axis Version

Touchscreen  
Touch screen



Joystickpanel mit Zoom- und Focusfunktion  
(nur für Objektive mit integrierten Motoren)  
Joy stick panel with zoom and focus control  
(only for lenses with integrated motors)

**P15 Art.Nr. / Item No. 8471-0 (2-Achsen-/Axis Vers.)**

**P15 Art.Nr. / Item No. 8470-0 (3-Achsen-/Axis Vers.)**

Inkl.

- Rahmen mit 2 (Pan, Tilt) bzw. 3 (Pan, Tilt, Roll) Achsenmodulen
- Kameraaufnahme mit Montageplatte
- Touchscreen
- Hauptsteuerkabel
- Akkuhalter für 2x V-Mount 24V (ohne Akku)
- Zubehör

Incl.

- frame with 2 (Pan, Tilt) or 3 (Pan, Tilt, Roll) modular axis
- camera plate incl. mounting plate
- touch screen
- main control cable
- battery holder for 2 V-Mount 24V (w/o batteries)
- accessories

2-Achsen-/Axis Version



3-Achsen-/Axis Version



- Unbegrenzte Rotation aller Achsen dank integrierter Schleifkontakte
- Antriebsachsen sind im Rahmen variabel justierbar für hohe Verwindungssteifigkeit
- Der P15 kann auch nachträglich mit einer dritten Achse aufgerüstet werden

- All three axes turnable by 360° due to slip-ring contacts
- The drive axes may be variably positioned in the frame
- The P15 may be even later upgraded with a 3rd axis

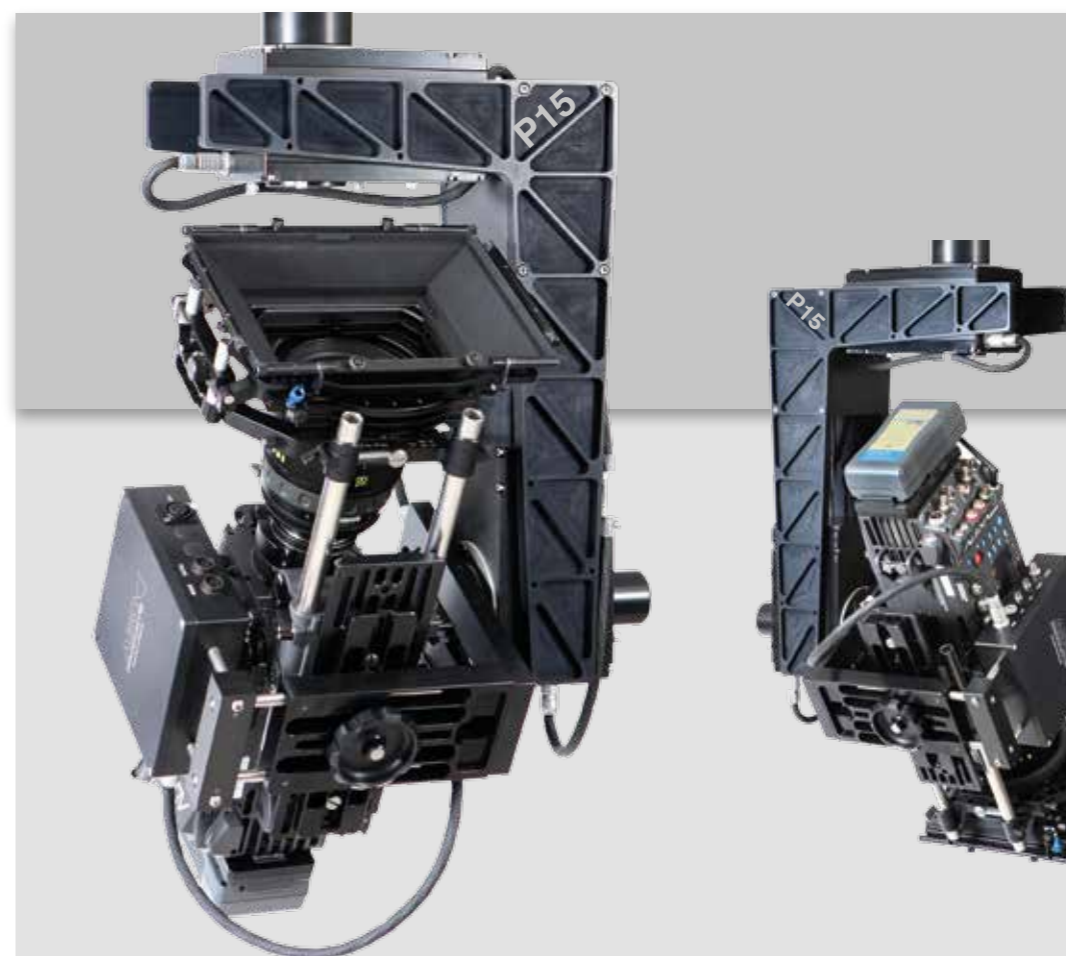

8470-7000



8470-9200

Pan Bar mit horizontaler und vertikaler Friktion  
Pan bar with horizontal and vertical brake

Zubehör / Accessories

8470-100	Modulbox für Zoom/Focus/Iris-Steuerung P15	Modular box for zoom/focus/iris control P15
8470-2600 8470-2700 8470-2800 8470-2900	Kabelsatz bestehend aus Zoom- und Focuskabel für Angenieux/Canon/Canon HD/ Fujinon (o.Abb.)	Set of cables consisting of zoom and focus cable for Angenieux/Canon/Canon HD/ Fujinon (not illustrated)
8470-7000 8471-7000	Einmannbedienung bestehend aus Handgriff Zoom/ Focus, Handgriff Joystick + Montagegestange, Wippe Roll-Achse (nur bei 3-Achsenversion)	One man control consisting of hand grip for zoom/ focus, joystick + mounting tube, zoom switch for roll axis (only with 3 axis version)
8470-9200	P 15 Pan Bar	P 15 Pan Bar
M1135	Rolltransportkoffer (für beide Versionen)	Transport case with wheels (for both versions)
8412-500	Netzteil	Power supply box



M1135



8412-500

Netzteil  
Power supply box



Zoom-/Focushandgriff  
Zoom-/focus hand grip



Joystickhandgriff  
Joystick hand grip



Wippe Rollachse  
Zoom switch for roll axis



8470-100



2114-01

2192



8321-03



7570-0SET



**MovieJib Art.Nr. | Item No. 2114-0**

**MovieJib - Jib-Arm mit variabler Auszugslänge und integrierter vertikaler und horizontaler Bremse. Max Zuladung 40 kg. Hubhöhe max. 2,79 m. Eigengewicht 41 kg.**

**Jib arm with variable extension length and integrated vertical and horizontal brake. Max payload 40 kg / 88.18 lb. Max Height 2.79 m. Weight 41 kg / 255.73 lb.**

mit Kurbelantrieb für stufenlose Gegengewichtsverstellung, Bullstand, Gegengewichtsstange, Transporttasche, Betriebsanleitung

incl. crank lever for weight counterbalance, tripod Bullstand, weight support tube, transport soft case, manual

**MovieJib – konsequent leicht und unglaublich flexibel.**

Die variable Auszugslänge des neuen MovieJib ist ohne Werkzeug in Sekunden verstellbar. Das Tarieren der Gegengewichte ist dabei durch den Kurbelantrieb, spielend leicht. Funktionelle Ausstattungsdetails wie die bequemen Handgriffe, eine horizontale und vertikale Bremse ermöglichen ein präzises Arbeiten.

**MovieJib – consistently lightweight and incredibly flexible.**

The variable extension length of the new MovieJib can be adjusted in seconds without any need for tools. Balancing the crane with the counterweights is very simple, thanks to the crank mechanism. Functional design details such as comfortable handgrips and a horizontal and vertical brake enable precise working.

Die Kamera kann „schwerelos“ geführt und dabei äußerst präzise geschwenkt werden.

The camera can be guided 'weightlessly' and swivelled with extreme precision.



**Zubehör / Accessories**

G2114-50	Adapter Euromount für Magnum	Adapter Euromount Magnum
2031-0	Kugelschale 150 mm	Ball adapter 150mm
2041-10	Mitchell Basisplatte (s. Seite 39)	Mitchell base plate (s. page 39)
2087-25	Euroadapter doppelt	Double euro-mount
2192	Koffer für Movie Jib	Hard case for MovieJib
7570-0SET	Kran-Dolly CD7 mit Lufrädern inkl. Säule und Säulenadapter	Crane Dolly CD7 with pneumatic wheels incl. column and column adapter
7703-0	Gegengewicht 4kg	Counterweight 4kg
7707-0	Gegengewicht 8kg	Counterweight 8kg
7715-0	Gegengewicht 16kg	Counterweight 16kg
8225-500	Akkuhalter NP1 mit Spannungsumwandler 12V Hirose 4pol w. (o. Abb.)	NP1 battery holder incl. voltage converter 12V (not illustrated)
8215-410	Akkuhalter V-Mount mit Spannungsumwandler 12V Hirose 4pol w. (o. Abb.)	V-Mount battery holder incl. voltage converter 12V (not illustrated)
8315-30	Monitorhalter für Movie Jib / Jib 100	Display support for Movie Jib/ Jib 100
8321-03	Stativ Bullstand	Tripod Bullstand
821421	Blendschutz für Monitor 7" (o. Abb.)	Sunshade for monitor 7" (not illustrated)
822420	Monitor TFT/ LCD 7" / 12V (o. Abb.)	Monitor TFT/ LCD 7" / 12V (not illustrated)
832100	Sandsack max. Füllgewicht 12kg (o. Abb.)	Sandbag 12 kg load-capacity (not illustr.)

Hoch hinaus – ganz ohne zusätzliche Abspannungen! Dadurch sind Kranfahrten auf engstem Raum möglich.

Reaching the stars – without any additional bracing! Crane movements are thus possible in even the tightest of spaces.

851200



Der MovieJib kann sowohl mit Stativ als auch auf den MovieTech Dollies flexibel montiert und eingesetzt werden.

The MovieJib can be installed and used flexibly with tripods as well as on MovieTech dollies

Horizontale Bremse und integrierte Libelle

Horizontal brake and integrated spirit level

Die Kugelschale kann am Krankopf an verschiedenen Positionen montiert werden – für mehr Bewegungsfreiheit und den flexiblen Einsatz von Zubehörteilen.

The ball adapter on the crane head can be set to various positions. This delivers greater mobility and allows the flexible use of accessory parts.



2087-25



2041-10



2031-0



8315-30



G2114-50



7715-0 7707-0 7703-0

**Jib 100** Art.Nr. | Item No. 8240-0

**Jib 100 - leichter Jibarm mit einem hohen Zuladungsgewicht von 20kg**  
**Jib 100 - lightweight jib with high payload capacity (20kg)**

teilbar, mit Gegengewichtsstange, Transporttasche, Betriebsanleitung

separable crane arm, with counterweight support bar, transport bag, user manual

Inkl.

- Jib mit Kranstütze und Euromountklemmung 80mm
- Kugelschalensadapter 75 oder 100mm
- Gegengewichtsstange (30mm Ø) inkl. QuickPin-Griffen
- Betriebsanleitung

Inkl.

- jib arm incl. head and euro mount adaptor 80mm
- ball adaptor for 75/100mm bowl tripods
- counterweight rod (30mm Ø) incl. quick pin handles
- manual

**JIB 100**



Monitorhalter  
display support

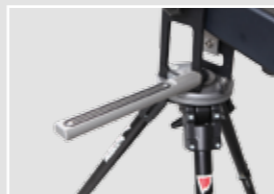

integrierte Nivellierung  
integrated leveling system

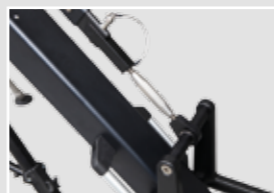

**Zubehör / Accessories**

G2114-50	Adapter Euromount für Magnum (s. Seite 25)	Adapter Euromount Magnum (s. Page 25)
2031-0	Kugelschale 150 mm (s. Seite 38)	Ball adapter 150mm (s. page 38)
2041-10	Mitchell Basisplatte (s. Seite 39)	Mitchell base plate (s. page 39)
2087-25	Euroadapter doppelt (s. Seite 38)	Double euro-mount (s. page 38)
7703-0	Gegengewicht 4kg (s. Seite 29)	Counterweight 4kg (s. page 29)
7707-0	Gegengewicht 8kg (s. Seite 29)	Counterweight 8kg (s. page 29)
7715-0	Gegengewicht 16kg (s. Seite 29)	Counterweight 16kg (s. page 29)
8225-500	Akkuhalter NP1 mit Spannungsumwandler 12V Hirose 4pol w. (o. Abb.)	NP1 battery holder incl. voltage converter 12V (not illustrated)
8215-410	Akkuhalter V-Mount mit Spannungsumwandler 12V Hirose 4pol w. (o. Abb.)	V-Mount battery holder incl. voltage converter 12V (not illustrated)
8315-30	Monitorhalter Movie Jib / Jib 100 (s. Seite 29)	Display support Movie Jib / Jib 100 (s.p. 29)
8321-01	Stativ 132X mit Lastenverstellung	Tripod 132X, modified with levelling system
821421	Blendschutz für Monitor 7" (o. Abb.)	Sunshade for monitor 7" (not illustrated)
822420	Monitor TFT/ LCD 7" / 12V (o. Abb.)	Monitor TFT / LCD 7" / 12V (not illustrated)
832100	Sandsack max. Füllgewicht 12kg (o. Abb.)	Sandbag 12 kg load-capacity (not illustrated)

**Master Jib** Art.Nr. | Item No. 4600-0 (R1-Version)

**Master Jib** Art.Nr. | Item No. 4600-0 (R1-Version)  
 Art.Nr. | Item No. 4600-01 (R2-Version)  
 Art.Nr. | Item No. 4600-02 (R3-Version)  
 Art.Nr. | Item No. 4600-03 (R4-Version)  
 Art.Nr. | Item No. 4600-04 (R5-Version)  
 Art.Nr. | Item No. 4600-05 (R6-Version)  
 Art.Nr. | Item No. 4600-06 (R6A-Version) (\*)  
 (\*) mit langem Endsegment / with long end segment.

Auslegerlänge / length: 1130 mm  
 Auslegerlänge / length: 1630 mm  
 Auslegerlänge / length: 2130 mm  
 Auslegerlänge / length: 2630 mm  
 Auslegerlänge / length: 3130 mm  
 Auslegerlänge / length: 3630 mm

Inkl.

- Kranstütze mit integriertem Basissegment und horizontaler und vertikaler Feststellbremse
- Parallelogrammstange
- Verlängerungssegmente (500/ 1000mm)
- Endsegment (500/1000mm)
- Gegengewichtsstange mit 5kg Feintrimmergewicht

Inkl.

- crane support with integrated main segment and vertical and horizontal brake
- parallelogram rod
- further segments (500/ 1000mm)
- end segment (500/ 1000mm)
- counterweight rod with 5kg counterweight for fine trimming

**MASTER JIB**

R1-Version  
version R1



R4-Version mit Remote Head P15  
(2-Achsenversion)  
version R4 with Remote Head P15  
(2 axis version)

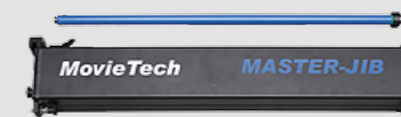

Alle austauschbaren Segmente  
in 500 und 1000mm  
All interchangeable segments  
in 500 and 1000mm



**Zubehör / Accessories**

	Monitorhalter	Display support
	Handgriffe	Handle bars
	Remote Head-Galgen	Remote Head adapter
	Jibausleger	Jib rig
	Transportrollkoffer	Roll case
7570-OSET	CD 7 Kranset	CD 7 Crane set

Gegengewichtsträger  
Counterweight rod



variabel positionierbarer Haltegriff  
the handhold can be positioned freely



Kranstütze mit horizontaler und vertikaler Bremse  
Crane support with horizontal and vertical brake



Gegengewichtsstange für die Aufnahme von Standardrundgewichten  
Counterweight rod for mounting standard round weights



integrierte horizontale und vertikale Bremse  
integrated horizontal and vertical brake



versetzbare Eurozapfenaufnahme  
adjustable adapter für euro mount







4400-220 (1,5 m)  
440015 (1 m)

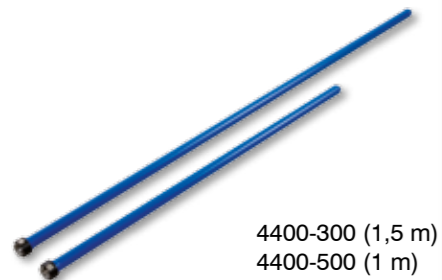

4400-300 (1,5 m)  
4400-500 (1 m)



4400-450

**MT 400** Art.Nr. | Item No. 4200-0

**MT 400 – Schwerlastkran, lange Version**  
**MT 400 – Heavy duty crane, long version**

Bestehend aus:

- 3 Kransegmenten 1m, 5 Kransegmenten 1,5m (Art. Nr. 4400-150, Art. Nr. 4400-220)
- Kranmittelteil mit Abstrebungsturm komplett (Art. Nr. 4400-120)
- 15 Abstrebungs- und Parallelogrammstangen 1,5 Meter (Art. 4400-300)
- 7 Abstrebungs- und Parallelogrammstangen 1 Meter (Art. Nr. 4400-50)
- 3 Parallelogrammstützen (Art. Nr. 4400-450)
- Gewichtskorb normal & Gewichtskorbzusatz (Art. Nr. 4400-700, 4400-800)
- 2 Endwippe (Art. 4400-350)
- Remotehead Aufnahmegalgen mit Mitchell Adapter (Weitere Adapter wie Euromount etc. auf Anfrage) ( Art. Nr. 4401-0)
- Basis mit Stützfüßen, Lufträdern und Schienenrädern (62cm), Drehgelenk, Mittelsäule, Schiebbestange (Art. Nr. 4402-0)
- Betriebsanleitung

Consisting of:

- 3 crane arm segments 1m, 5 crane arm segments 1,5m (Item No. 4400-150, Item No. 4400-220)
- main segment with complete bracing (Item No. 4400-120)
- 15 support- and parallelogram rods 1,5m (Item No. 4400-300)
- 7 support- and parallelogram rods 1m (Item No. 4400-50)
- 3 parallelogram rod supports (Item No. 4400-450)
- counterweight basket & extra counterweight basket
- 2 mounting connections (Item No. 4400-350)
- remote head mount with Mitchell adapter (Item No. 4401-0)
- base with leveling legs, pneumatic wheels and track wheels (62cm), swivel joint, middle column, push bar (Item No. 4402-0)
- manual



4402-400SET



4401-0



4408-0



4406-0



4400-700

**MT400**

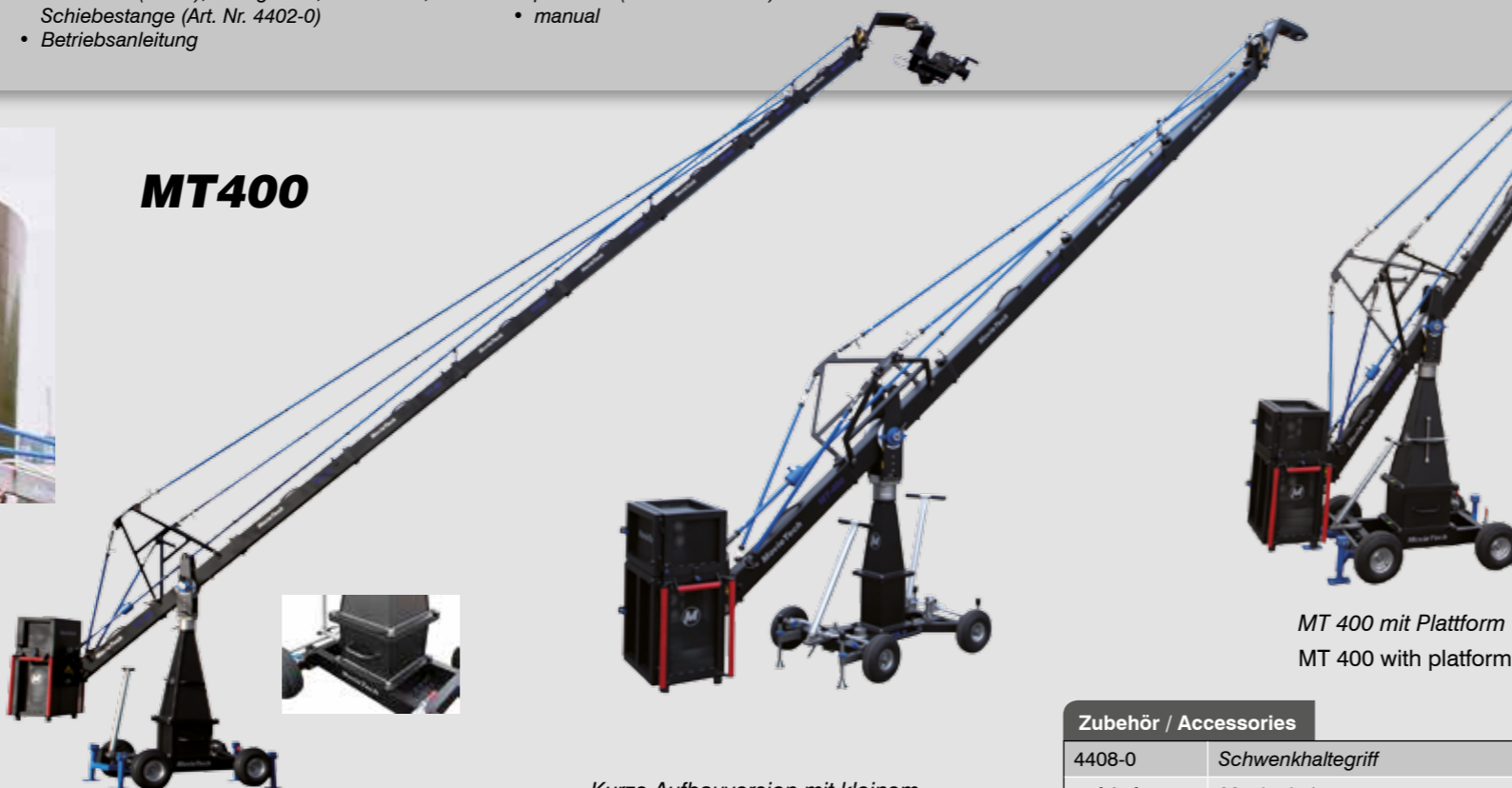

MT 400 mit Remote Head  
MT 400 with remote head

Kurze Aufbauversion mit kleinem Abstrebungsturm  
Short assembly with small bracing

MT 400 mit Plattform  
MT 400 with platform



Praktisch transportierbar: Abstrebungsstangen können in Segmenten verstaut werden.  
Easy transport: Bracing rods can be stored in crane segments



Großer Turm für Abstrebung  
Bracing big



4100-200  
4100-220

Kleiner Turm für Abstrebung  
Bracing small

Mit nur zwei verschiedenen Abstrebungs- sowie Parallelogrammstangen und entsprechenden Kranarmsegmenten in 1m und 1,5m Länge, besteht der MT-Kran durch seine enorm kurzen Rüstzeiten. Durch ein intelligentes Verbindungssystem gehören auch die gerne am Drehort verlorenen „Pushpins“ der Vergangenheit an. Der MT 400 ist zudem berechtigt die BG-PRÜFZERT-Plakette zu tragen.

With only two different bracing and parallelogram bars as well as corresponding crane-arm segments with a length of 1 m and 1.5 m, the MT crane system is the compelling choice due to its extremely short set-up times. Thanks to its intelligent connection system, the "push pins" which were forever being lost at the filming location are now a thing of the past. The MT 400 is entitled to bear the BG-PRÜFZERT badge.

**Zubehör / Accessories**

4408-0	Schwenkhaltegriff	Panning handle adjustable
auf Anfrage	Monitorhalter	Display support
4401-0	Remote Head-Aufnahmegalgen	Remote head mount
4406-0	Plattform mit Drehkreuz	Platform with turnstile
4400-700	Gewichtskorb MT400	Counterweight cage MT400
4400-800	Zusatzgewichtskorb	Extra counterweight cage
4402-400SET	Säulenverlängerung	Risor for column
4408-0	Handgriff	Handle

sowie Sitzarme, Sitze...../ as well as seat arms, seats etc.

**kann auch verkleinert werden mittels folgenden Zubehörs:**

4100-200	Abstrebungsturm klein rechts	Bracing small, right
4100-220	Abstrebungsturm klein links	Bracing small, left

4400-800





Funktionelles Design ist kennzeichnend für den neuen MovieTech Kran MT400. Ein Beispiel hierfür ist der starke Basisdolly mit seinem optional erhältlichen „on board“ Transportsystem. Alle Kranteile finden zuverlässig ihren Platz – das spart Zeit!

The functional engineering design of the MT400 is also evident in the design of the base-dolly. With the optional "on-board" transport accessories, it turns into a fully integrated transport-trolley for all of the MT400 components.



4405-0

MT400 Basis mit Holzplattform (Zubehör optional)  
MT400 base with wooden platform (accessories are optional)



MT400 Basis  
MT400 base



N200-1000



Klemmbolzen zur Aufnahme von Sitzarmen und weiterem Zubehör  
Clamp bolt for mounting seat arms and further accessory parts



4403-0SET

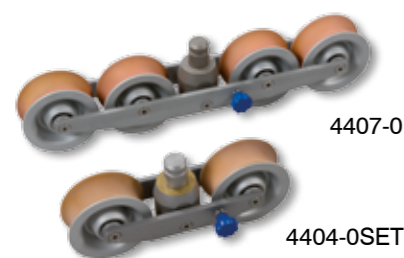

4407-0

4404-0SET

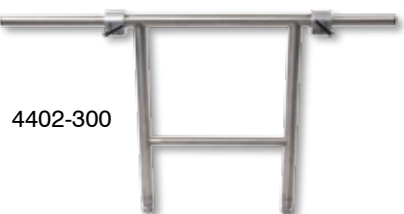

4402-300

Zubehör / Accessories

4405-0	Transportsystem „on board“ für MT 400	Transportsystem „on board“ for MT 400
4402-300	Schiebestange	Push bar
N200-1000	Klemmbolzen	Clamp bolt
7740-0	Schalensitz mit Automatik-Sicherheitsgurt	Cushioned seat with auto-rewind seat belt
2054-0	Sitzarm senkrecht 10 cm	Seat arm vertical 10 cm/4"
2055-0	Sitzarm Senkrecht 20 cm	Seat arm vertical 20 cm/8"
2056-0	Sitzarm Senkrecht 30 cm	Seat arm vertical 30 cm/12"
7716-0	Gegengewicht 16kg	Counterweight 16kg
7708-0	Gegengewicht 8kg	Counterweight 8kg
7704-0	Gegengewicht 4kg	Counterweight 4kg
7705-0	Transportbehälter für 6 Kran-Gegengewichte	Carrier for 6 crane weights
4407-0	Schienenradsatz 4-fach für MT400	Track wheel set 4-pieces for MT400
4404-0Set	Schienenradsatz 2-fach für MT400	Track wheel set 2-pieces for MT400



Das MT400 Kransystem wird von einem großen Sortiment an Zubehörteilen umfassend ergänzt. MasterTrack und MovieTrack Schienen, Monitorhalter, diverse Säulenverlängerungen, spezielle Kransitze und viele weitere Produkte aus dem Hause MovieTech können miteinander vielseitig kombiniert werden.

A wide range of crane accessories such as the Master Track and Movie Track system, monitor holders, various column extensions, special crane seats, etc. rounds off the MT400 crane system. Most of these accessories are also suitable for use with other MovieTech products.



7740-0



2054-0 2055-0 2056-0



7716-0 7708-0 7704-0



7705-0

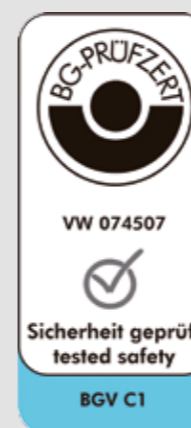



62 cm: 2500-0 100 cm: 2580-0  
2501-0 2581-0  
2502-0 2582-0



2540-0



62 cm: 2560-0 100 cm: 2561-0



2665-0



2594-0  
2595-0



M5622

Master Track Art.Nr. | Item No. 25xx-0

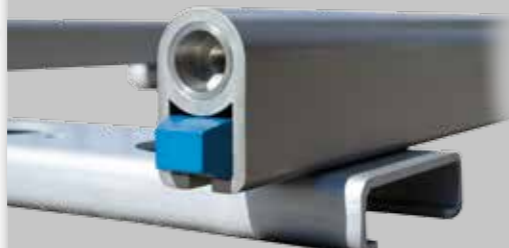

Das einteilige Profil der **MasterTrack** Aluminium Schiene bietet ein Maximum an Steifigkeit in Kombination mit einem niedrigen Gewicht.

The one-piece profile of the Master Track System offers a maximum of stiffness in combination with low weight.

(M.T. = Master Track, Spw. = Spurweite)

- 2500-0 M.T. gerade 90 cm Klappbar, 62cm Spw.
- 2501-0 M.T. gerade 160 cm Klappbar, 62cm Spw.
- 2502-0 M.T. gerade 230 cm Klappbar, 62cm Spw.
- 2520-0 M.T. gerade 90 cm Starr, 62 cm Spw.
- 2521-0 M.T. gerade 160 cm Starr, 62 cm Spw.
- 2522-0 M.T. gerade 230 cm Starr 62 cm Spw.
- 2540-0 M.T. Kurve 45° (1/8 Kreis)
- 2570-0 M.T. gerade 90 cm Starr, 100 cm Spw.
- 2571-0 M.T. gerade 160 cm Starr, 100 cm Spw.
- 2572-0 M.T. gerade 230 cm Starr, 100 cm Spw.
- 2580-0 M.T. gerade 90cm Klappbar, 100cm Spw.
- 2581-0 M.T. gerade 160cm Klappbar, 100cm Spw.
- 2582-0 M.T. gerade 230cm Klappbar, 100cm Spw.

- 2500-0 M.T., Foldable 24.5", straight 3 ft
- 2501-0 M.T., Foldable 24,5", straight 5 ft
- 2502-0 M.T., Foldable 24,5", straight 7,5 ft
- 2520-0 Fixed Track 24,5", straight 3 ft
- 2521-0 Fixed Track 24,5", straight 5 ft
- 2522-0 Fixed Track 24,5", straight 7,5 ft
- 2540-0 Curve 45° (1/8 circle)
- 2570-0 Fixed Track 39", straight 3 ft
- 2571-0 Fixed Track 39", straight 5ft
- 2572-0 Fixed Track 39", straight 7,5 ft
- 2580-0 Foldable Track 39", straight 3 ft
- 2581-0 Foldable Track 39", straight 5 ft
- 2582-0 Foldable Track 39", straight 7,5 ft



2593-0

Zubehör / Accessories

2665-0	Schienen-Endanschlag	Track and stop set (two pcs.)
2560-0	Auffahrrampe 62 cm	Drive ramps 24,5"
2561-0	Auffahrrampe 100 cm	Drive ramps 39"
2587-0	Abzieher für Schienen Zapfen (o. Abb.)	Puller for track pin (not illustrated)
2591-0	Adapter für Rohrschiene 4 Stck (o. Abb.)	Adapter set (4 pcs.) for tubular track (not illustrated)
2592-0	Ausgleichstück Master Track (62cm auf 36cm)	Narrow gauge adapter for Master Track (62cm to 36cm)
2593-0	Ausgleichstück Master Track (100cm auf 62cm)	Narrow gauge adapter for Master Track (100cm to 62cm)
2594-0	Schutzschraube für Schienenendstück männlich	Protection cap for trackend section, male
2595-0	Schutzschraube für Schienenendstück weiblich	Protection cap for track end section, female
2665-0	Schienenstopper-Set für Movie/Master Track (o. Abb.)	Track-endstop set for MovieTrack/MasterTrack (not illustrated)
M5622	Schutzkappe rot für Master Track Schiene	Protection cap for Master Track
M5949	Spannschloß für Schienen	Tiebrace for tracks
2604-0	Adapter Set MasterTrack auf Movie Track	Adapter set Master Track on Movie Track

Movie Track Art.Nr. | Item No. 26xx-0



Die **MovieTrack** Stahlschiene ist aus hochwertigem Stahl mit besonderer Oberflächenveredelung hergestellt. In der Konstruktion und Verarbeitung des Schienenrohrs wird auf die hohe Präzision der kalibrierten Rohre geachtet, um perfekte Schienenübergänge zu gewährleisten.

The steel track is made of high-grade steel with special surface coating. The design and manufacturing of the track tube is focused on a precise manufacturing to assure smooth track-to-track transitions.

- 2600-0 Movie Track CrX 0,9m starr/klappbar – fixed/foldable 62 cm
- 2601-0 Movie Track CrX 1,6m starr/klappbar – fixed/foldable 62 cm
- 2602-0 Movie Track CrX 2,3m starr/klappbar – fixed/foldable 62cm
- 2640-0 Movie Track CrX Kurve/curve 45° 62 cm



Steel System



Zubehör / Accessories

2603-0	Movie Track CrX Auffahrrampe 62cm	Movie Track CrX ramp
2604-0	Adapter Set MasterTrack auf Movie Track	Adapter set Master Track on Movie Track
2665-0	Schienenstopper Movie/Master Track einzeln (o. Abb.)	Track-endstop separate for MovieTrack/MasterTrack (not illustrated)
2692-0	Ausgleichstück Movie Track (62cm auf 36cm)	Narrow gauge adapter for MovieTrack

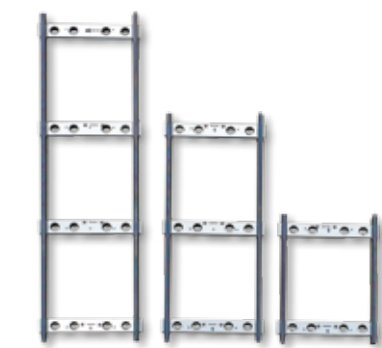

62 cm: 2600-0  
2601-0  
2602-0

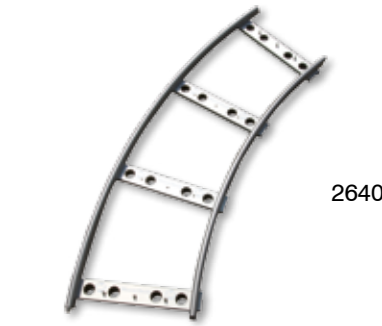

2640-0



62 cm: 2603-0

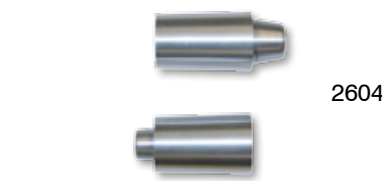

2604-0



M5949

2024-0

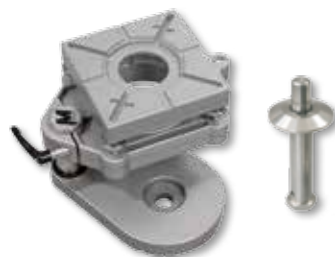

Die starren und verstellbaren Säulenverlängerungen können bei Bedarf verschraubt werden. Der Klemmring ist um 360° drehbar. Im Lieferumfang der starren Bazooken enthalten sind Ringschrauben die - falls erforderlich - eine zusätzlich Abspannung zur Stabilisierung ermöglichen.

The fixed and adjustable column extensions can be bolted-down if necessary. The locking ring swivels 360°. Eyebolts are part of the delivery of the fixed riser and give - if required - additional bracing for stabilization.

2026-0



2027-0



2030D-1



2031-3



2032-1



2032-0

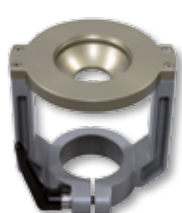

2031-0



2087-25



2042-0

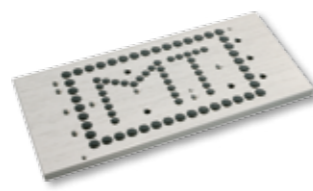

2244-01



2033-0

2036-0

2034-0

2037-0

2035-0

2038-0

◆ Ø 150mm

◆ Ø 100mm

2048-0



2051-0



2052-0



2053-0



2054-0



2055-0



2056-0



2131-0



2205-0

2131-0



Zubehör / Accessories

2024-01	4 Weg Mitchell Nivellierung von Euro auf Mitchell (lange Version) (o. Abb.)	4 Way Leveller Mitchell from euro to mitchell (long version) (o. Abb.)
2024-02	4 Weg Mitchell Nivellierung von Euro auf Mitchell (kurze Version)	4 Way Leveller Mitchell from euro to mitchell (short version)
2024-0	4 Weg Mitchell Nivellierung auf Mitchell	4 Way Leveller Mitchell to Mitchell
2026-01	Adapter von Mitchell auf Eurozapfen mit langem Bolzen (o. Abb.)	Adapter from Mitchell on euromount with long bolt (not illustrated)
2026-0	Adapter von Mitchell auf Eurozapfen mit kurzem Bolzen	Adapter from Mitchell on euromount with short bolt
2031-3	Kugelschaleneinsatz 150mm	Bowl insert, 150mm
2030D-1	Mitchell Basisplatte für Kombikugelschale	Mitchell-base plate for combi ball adapter
2031-0	Kugelschale 150 mm	Ball Adapter 150 mm
2041-10	Mitchell Basisplatte	Mitchell-base plate
2032-1	Kugelschaleneinsatz 100mm (o. Abb.)	Bowl insert, 100mm (not illustrated)
2032-0	Gerade Kugelschale 100 mm	Bowl adapter straight 100mm
2033-0	Seitenschale 150 mm kurz	Off-Set ball adapter 150 mm short
2034-0	Seitenschale 150 mm mittel	Off-Set Ball Adapter 150 mm middle
2035-0	Seitenschale 150 mm lang	Off-Set Ball Adapter 150 mm long
2036-0	Seitenschale 100 mm kurz	Off-Set Ball Adapter 100 mm short
2037-0	Seitenschale 100 mm mittel	Off-Set Ball Adapter 100 mm long
2038-0	Seitenschale 100 mm lang	Off-Set ball adapter 150 mm short
2042-0	Low-Shot Plate	Low Shot Plate
2044-1	Euroadapter	Euro Adapter for connection bolt
2048-0	Kugelschale auf Mitchell	Ball-Adapter to Mitchell
2049-01	Seitenschale 100 mm XL (o. Abb.)	Side bowl, extra long 100mm (not illustr.)
2049-0	Seitenschale 150 mm XL (o. Abb.)	Side bowl, extra long 150mm
2051-0	Sitzarm 10 cm	Seat arm combined 10 cm/4"
2052-0	Sitzarm 20 cm	Seat arm combined 20 cm/8"
2053-0	Sitzarm 30 cm	Seat arm combined 30 cm/12"
2054-0	Sitzarm senkrecht 10 cm	Seat arm vertical 10 cm/4"
2055-0	Sitzarm senkrecht 20 cm	Seat arm vertical 20 cm/8"
2056-00	Sitzarm senkrecht 30cm	Seat arm vertical 30 cm/12"
2057-1	Verbindungsbolzen	Connection Bolt
2058-0	Sitz rund für Dolly	Round seat for Dolly
2065-1	Adapterring von 150mm auf 100mm Kugel	adapter ring from 150 to 100mm bowl
2082-0	Seitenausleger, verstellbar, drehbar	Adjustable off-set arm
2083-0	Seitenausleger kurz	Off-set arm short
2086-0	Euroadapterseitenverlängerung	Off-set Euro-Adapter Extension
N200-1000	Klemmbolzen	Clamp bolt
2091-0	Drehgelenk mit Feststellbremse	Rotable Adapter with brake

2057-1



2058-0



2065-1



2041-10

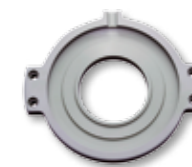

2082-0



2083-0



2086-0



2091-0



N200-1000



Die original MovieTech Accessories entsprechen höchsten Qualitätsansprüchen. Viele Teile sind universell auf den verschiedenen MovieTech Geräten einsetzbar.

The original MovieTech accessory parts meet the highest quality demands. The majority can be mounted on all different MovieTech devices.



Zubehör / Accessories

2075	Werkzeugkoffer	Tool case
2104-0	Mini Tiefausleger	Mini Low Rig
2105-0	Adapter Mini Tiefausleger	Adapter for Mini Low Rig
2113-0	Eurozapfen auf 28mm Lichtzapfen	Euromount on 28mm lightstud
2115-0	Adapter Mini-Tiefausleger „L“	Adapter for Mini Low Rig, long
2116-0	Adapter Mini-Tiefausleger „M“	Adapter for Mini Low Rig, middle
2130-0	Säulenverlängerung 10cm	Riser 10 cm / 4"
2131-0	Säulenverlängerung 20 cm	Riser 20 cm / 8"
2132-0	Säulenverlängerung 30 cm	Riser 30 cm / 12"
2133-0	Säulenverlängerung 40 cm	Riser 40 cm / 16"
2134-0	Säulenverlängerung 50 cm	Riser 50 cm / 20"
2135-0	Säulenverlängerung verstellbar 39-73 cm	Riser Adjustable 39-73 cm
2150-0	Säulenverlängerung Version Rohr Euro 20 cm	Riser tube typ euro 20cm
2151-0	Säulenverlängerung Version Rohr Euro 30 cm	Riser tube typ euro 30cm
2152-0	Säulenverlängerung Version Rohr Euro 40 cm	Riser tube typ euro 40cm
2153-0	Säulenverlängerung Version Rohr Euro 50 cm	Riser tube typ euro 50cm
2154-0	Mitchell Schlüssel (o. Abb.)	Spanner for Mitchell bazooka (not illustr.)
2155-0	Säulenverlängerung Version Rohr Mitchell 20cm	Riser tube typ mitchell 20 cm
2156-0	Säulenverlängerung Version Rohr Mitchell 30cm	Riser tube typ mitchell 30 cm
2157-0	Säulenverlängerung Version Rohr Mitchell 40cm	Riser tube typ mitchell 40 cm
2158-0	Säulenverlängerung Version Rohr Mitchell 50cm	riser tube typ mitchell 50 cm
2201-0	Universalsicherungsplatte für Schalen	Universal safety plate for Ball Adapter
2205-0	Rocker Platte	Rocker Plate
2210-01	Mini Bodenstern mit 150 mm Kugelschale	Mini Spoke Base with 150 mm Ball Adapter
2210-0	Mini Bodenstern mit Euroadapterzapfen	Mini Spoke Base with 150 mm Ball Adapter
2211-01	Maxi Bodenstern mit 150 mm Kugelschale	Maxi Spoke Base with 150 mm Ball Adapter
2211-0	Maxi Bodenstern mit Euroadapter	Maxi Spoke Base with Euro Adapter Mount
2240-0	Stativadapter mit Eurozapfen für Stativ 150 mm/ 3/8"	Tripod Adapter with euro mount for tripod 150mm/ 3/8"
2241-0	Stativadapter mit Eurozapfen für Stativ 100 mm	Tripod Adapter with Euro adapter mount 100 mm
2242-0	Vinten auf Euro-Adapter	Vinten on Euro adapter mount
2244-01	Euroadapter	Euro adapter mount on Vinten
2248-0	Eurozapfen auf Gerüstschelle	Euromount with scaffold clamp
2270-100	Movie Tech Praktikabel 100x100x50 cm	Movie Tech rostrum 100x100x50 cm
2270-150	Movie Tech Praktikabel 100x100x100 cm	Movie Tech rostrum 100x100x100 cm
2280-1	Holzplattform 100x100 für Praktikabel	Wooden platform for rostrum (100x100)

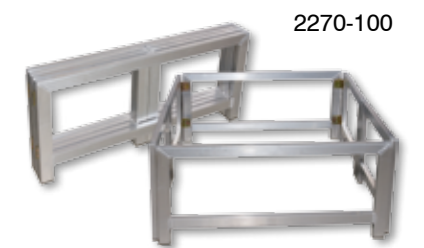
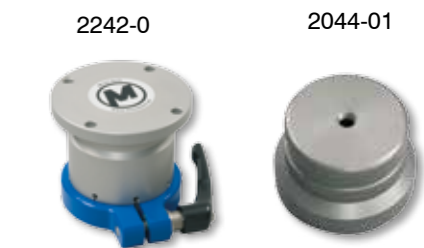
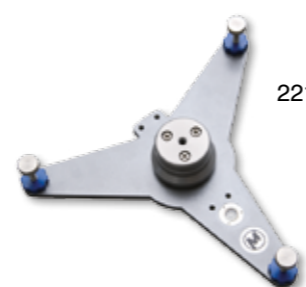
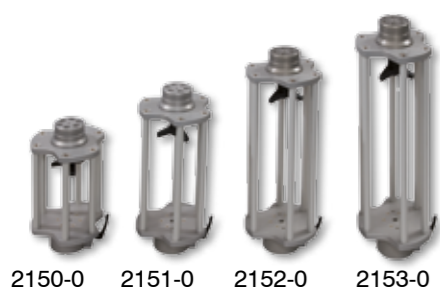
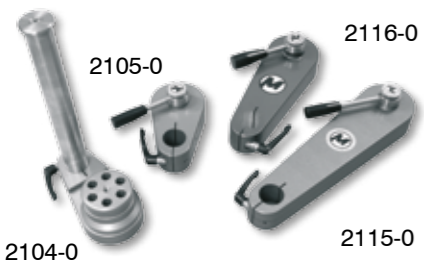

2168



Die MovieTech Zubehörkoffer werden für die einzelnen Artikel individuell angepasst und hinsichtlich Ausstattung, Stabilität und Funktionalität maßgeschneidert gefertigt.

The MovieTech accessory cases are customized for the individual items and are manufactured with regard to outfitting, stability and functionality.

2160



2161



2165



2166



2160	Koffer für Magnum Dolly	Case for Magnum dolly
2161	Koffer für Magnum Säule	Case for column
2165	Koffer für Alu-Plattform	Case for aluminium platform set
2167	Koffer für Duo Jib komplett	Case for Duo Jib complete
2168	Koffer für Systemausleger	Case for system low rig
2169	Koffer für Mini Jib	Case for Mini Jib arm
2170	Koffer für Tiefausleger	Case for low rig
2171	Koffer für Komfortausleger / U-Bangi	Case for U-Bangi
2172	Koffer für Schienenräder Magnum	Case for track wheels Magnum dolly
2173	Koffer für Satz Säulenverlängerungen	Case for a set of risers
2174	Koffer für Lufträder / Studioräder	Case for pneumatic / studio wheels
2175	Koffer für Elektronik und Handregler	Case for electronic and handcontrol
2176	Koffer für Kombikugelschale	Case for combi ball adapter
2177	Koffer für Magnum Netzteil	Case for power supply Magnum
2181	Koffer für Rocker Platte	Case for Rocker Plate
2192	Koffer für Movie Jib	Case for Movie Jib
2166	Koffer Dolly Zubehör	Case for dolly accessories
2193	Koffer für Bullstand 120 Stativ	Case for Bullstand 120 tripod
2963	Koffer für Schienenradsatz Kurve	Case for trackwheelset Sprinter curve
220650	Transportkoffer für Rocker Dolly	Case for Rocker Dolly
M1135	Koffer für Remote Head P15	Case for remote head P15



2167



2172



2173



2174



2175



2963



2176



2177



2181



220650



M1135



2171



2170



2169



2192



2197

Lieferung der Koffer jeweils ohne Inhalt

Delivery of the cases without products

# M MovieTech

[www.movietech.de](http://www.movietech.de)

Die MovieTech AG mit Hauptsitz in München und Tochtergesellschaften in Mailand und Prag produziert und vermarktet als einer der führenden Hersteller Produkte und Lösungen für die Film- und Fernsehindustrie.

Die Produktpalette von MovieTech konzentriert sich auf die Bereiche: Kamerakräne, Dollies, Lichtsysteme, Remote Heads und entsprechendes Zubehör.

Ziel der Movie Tech AG ist die Herstellung von professionellem Filmequipment, das die Arbeit der Anwender am Set oder im Studio wesentlich erleichtert und die Umsetzung der kreativen Ideen ermöglicht.

The MovieTech AG is based in Munich with subsidiaries in Milan and Prague. As one of the leading manufacturers in its field, it produces and markets products and solutions for the film industry.

The MovieTech product range concentrates on the areas of: Camera cranes, dollies, remote heads and corresponding accessories, as well as studio and stage techniques.

The MovieTech mission is the manufacture of professional film equipment that not simplifies the work of those using it on the set or in the studio, but also facilitates the implementation of creative ideas.

## M MovieTech

[www.movietech.de](http://www.movietech.de)



Dollies – Cranes – Remote Heads

## ABC PRODUCTS

[www.abc-products.de](http://www.abc-products.de)



Steadycam systems – Light dollies – Light cranes

## MTS Media Technical System

[www.mts-germany.com](http://www.mts-germany.com)



Pantographs – Hoists – Telescopes – Trolleys

## LASTRO ENGINEERING

[www.lastro.de](http://www.lastro.de)



Rail systems – Studio and stage engineering

### MovieTech AG (Germany)

Martin-Kollar-Str. 9 • 81829 München • Tel: +49 (0)89-43 68 91 3 • Fax: +49 (0)89-43 68 91 55 • E-Mail: [info@movietech.de](mailto:info@movietech.de)

### MovieTech S.r.l. (Italia)

Viale Edison 318 • 20099 Milano • Tel: +39 (0)2 22 47 00 43 • Fax: +39 (0)2 24 41 01 63 • E-Mail: [k.shore@movietech.de](mailto:k.shore@movietech.de)